



TOGETHER
TOWARDS
TOMORROW

SENSORIAL EXPERIENCE, ELEVATED

Rediscover our iconic GG fragrances

ORIFLAME

— S W E D E N —

Catalogue 12 2022 (03/08 – 23/08)



CATALOGUE MENU

Beauty by Sweden

HIGHEST SAFETY STANDARDS



RESPONSIBLE DEVELOPMENT



Beauty is a feeling

Make-up

Personal care

For him





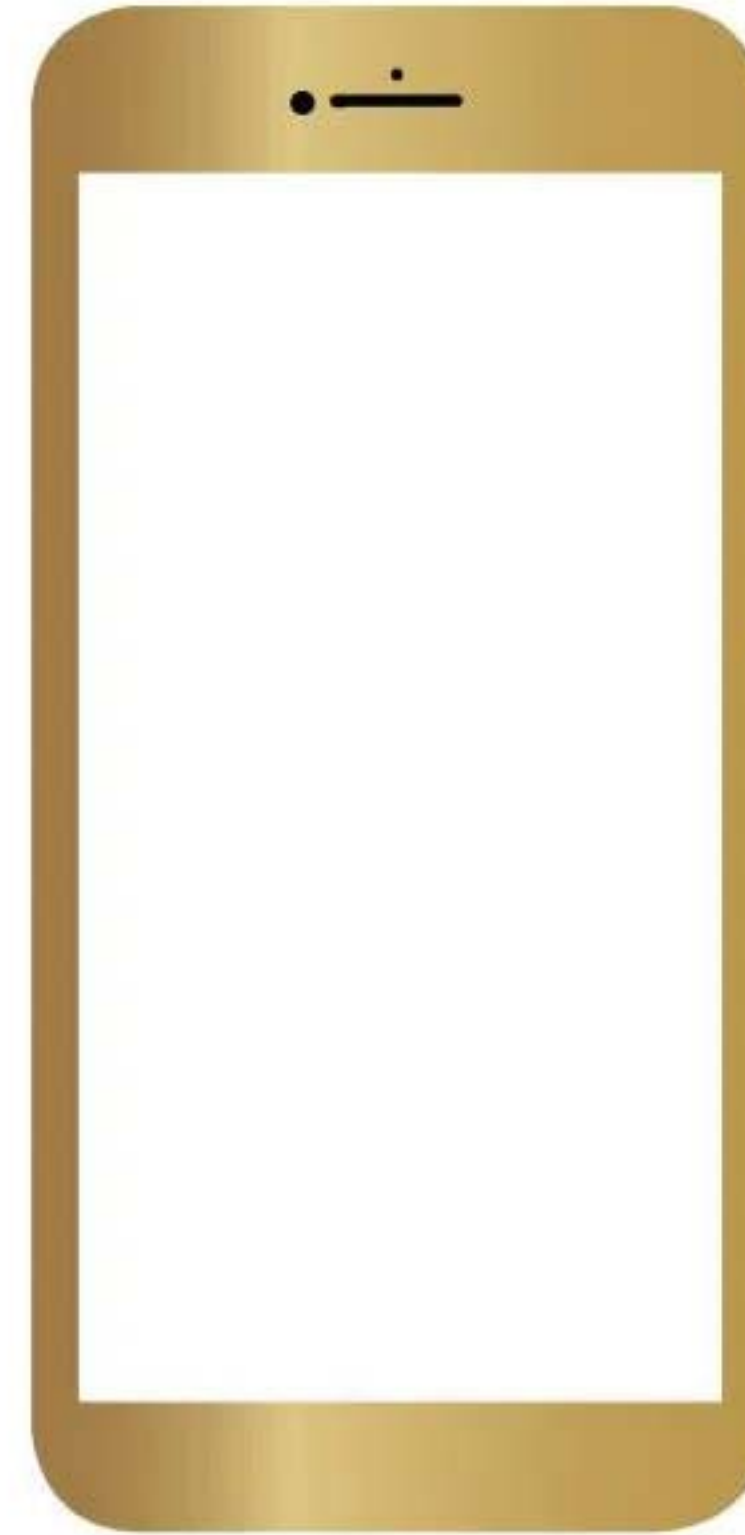

Fragrance

Wellness

Skin care

Norrskén



-  Add to shopping bag
-  Special offer
-  Additional content
-  Return to menu
-  More information
-  Play video

HOW TO BROWSE AND SHOP



Swipe to browse or click on a section in the menu to go to it immediately.



Press the icons to view additional content and product information.



Press the bag icon to add a product to your shopping bag.



Press the shopping bag icon at the top of the screen to complete your order.



A NEW DEFINITION OF CRAFT

Explore the luminous freshness of sun-drenched Mandarin and Orange Blossom crafted around a beautifully feminine white floral bouquet. Relish in the lingering warmth of woody Patchouli accents. This Eau de Parfum truly captures the passion and vitality of the GG Woman.



"I always strive to approach perfumery with a creative sense of freedom. With Giordani Gold Woman, I aimed to evoke the signature scent of highly elegant and feminine women."

Alexandra Carlin

YOUR BELOVED TIMELESS SCENT. NEW ELEVATED DESIGN.

NEW!



FLORAL WHITE FLOWERS WOODY
Mandarin, orange blossom, Patchouli

●●●○
VERY HIGH FRAGRANCE CONCENTRATION



① Giordani Gold Woman Eau de Parfum 50ml
Merch price/100ml: £49.98

38531 ~~£34.00~~
£24.99



② Giordani Gold Woman Perfumed Roll-On Deodorant 50ml
Merch price/100ml: £4.98

43665 ~~£4.00~~
£2.49



MIX & MATCH: BUY ANY 2 GG EAU DE PARFUMS

for only

£21.99

each

You can choose one fragrance for Her and one for Him, two fragrances for Her or two fragrances for Him.



A NEW STATE- OF-MIND LUXURY

Exude suave masculine sensuality with a refined Eau de Parfum, where zesty Bergamot melds with spicy Black Pepper to create a bright and powerful opening. Delight in the nobleness of Vetiver, which elevates this elegant fragrance to a multifaceted experience full of sensorial depth.



„When crafting Giordani Gold Man, I had in mind a gentleman appreciating aesthetic things and quality products – who would expect his fragrance to be all this at the same time.“

Maurice Roucel

6

YOUR BELOVED
TIMELESS SCENT.
NEW ELEVATED DESIGN.

NOW IN EAU DE
PARFUM VERSION

NEW!



WOODY VETIVER
Bergamot, Black pepper, Vetiver

●●●○
VERY HIGH FRAGRANCE
CONCENTRATION



① Giordani Gold Man
Eau de Parfum
75ml Merch price/100ml: £33.32

38538 ~~£34.00~~
£24.99

② Giordani Gold Man
Anti-perspirant Roll-On
Deodorant
50ml Merch price/100ml: £4.98

42204 ~~£4.00~~
£2.49

7



**MIX & MATCH:
BUY ANY 2
GG EAU DE
PARFUMS**

for only

£21.99

each

You can choose one
fragrance for Her and one
for Him, two fragrances
for Her or two fragrances
for Him.

BAG ORGANISER



YOURS
FOR ONLY
£6.99

WHEN YOU SPEND £20
IN THIS CATALOGUE

SAVE £5.00

8



△ Simply slip into your
handbag



*Products shown in the picture
are not included*

9

NEW!
LIMITED EDITION

Moving handbags made simple

CHANGING OUTFITS?
CHANGE THE HANDBAG TOO!
Quickly and easily. Multiple slots
and compartments of this bag
organizer help keep all your daily
essentials in order and always at
hand for you.

Bag Organiser
Clever case in midnight-blue felt, fitted with plenty
of compartments for easy organisation in
handbags. Polyester. L:25.5 x W:10 x H:15 cm.

45894 £11.99



SWEDISH
SPA

FEEL THE MULTISENSORIAL HARMONY

Swedish Spa offers ultimate relaxation for your body and soul. The range pampers your skin with rich textures and caresses senses with aquatic scent. It is the perfect way to unwind when you need it most.

2-sided soap: massages,
stimulates circulation
and exfoliates



① Swedish Spa Smooth Rocks Exfoliating Massage Soap Bar

Versatile cleansing bar that massages and stimulates circulation with one side and exfoliates with the other. Relaxing aquatic floral scent. 100g
Merch price/100g: £2.49

34021 ~~£4.50~~
£2.49



**BEST
SELLER**



Luxuriously nourishing
hand mask for silky
soft hands

② Swedish Spa Soft Tide Hand Mask

Luxurious, highly-nourishing and moisturising hand mask to leave hands soft, supple and relaxed. With relaxing Swedish Spa scent. 75ml
Merch price/100ml: £6.65

34730 ~~£10.00~~
£4.99



FEEL YOUR SKIN SOFT AND PAMPERED

Tender Care comes in many splendid variants, all of which are formulated with natural extracts and contain a blend of emollients, Beeswax and Vitamin E to keep your skin moisturised, nourished and protected.

Adored by millions, you'll love it too!



TENDER CARE LOVED
SINCE 1980

WITH POMEGRANATE SEED
oil which is naturally fit for
protecting the skin from
free-radical damage.



WITH ROSE OIL
to restore hydration,
soften and protect dry skin
and pamper senses with
delightful scent.



**BEST
SELLER**

① Tender Care Rose
Protecting Balm
15ml Merch price/10ml: £3.33
30861 ~~£8.00~~

② Tender Care Protecting Balm
with Organic Pomegranate Seed
Oil
15ml Merch price/10ml: £3.33
34042 ~~£8.00~~

EACH ONLY
£4.99



FEEL FREE TO EXPRESS YOUR STYLE

Plain colour is not enough? The One Nail Art Collection, made up of 6 new matte and metallic shades with high-precision brushes, equips you with the right tools to create true masterpieces. Bring out your artistic side - your nails are your canvas!

NEW!
LIMITED EDITION

POSITIVELY STUNNING GLOSS

41780 Sand Buff Cream	41781 Rose Lace Shimmer	41782 Twinkly White Shimmer
41871 Sweet Milk Cream	41872 Rosy Nude Cream	41873 Clover Love Shimmer
41874 Icy Lavender Cream	41875 Crystal Water Shimmer	41876 Turquoise Bliss Cream
41877 Mystic Aqua Shimmer	41878 Blue Decadence Shimmer	41879 Boysenberry Touch Cream
41880 Night Orchid Cream	41881 Fuchsia Allure Cream	
41883 Watermelon Punch Cream	41885 London Red Cream	
41888 Very Ebony Cream	41890 Rose Diamond Shimmer	
41886 Ruby Rouge Cream	41882 Cupcake Rose Cream	

SALON STYLE NAIL ART AT HOME!



① THE ONE Gloss N' Wear Nail Lacquer
8ml
Merch price/10ml: £6.24
£7.00

② THE ONE Pro Wear ART Nail Lacquer
5ml
Merch price/10ml: £9.98
£9.00



Buy any 1 for
£4.99

Buy any 2 for only
£3.99 each

3-in-1 Contour Like a Pro



Define and sculpt with blendable and buildable shades of bronzer, blush and highlighter.

36127
Classy



LIMITED EDITION



Soft and flexible contouring stencil for naturally sculpted cheekbones and a defined jawline

① THE ONE Contouring Kit
13.1g
Merch price/10g: £6.86

£16.00
£8.99

② Cheek Contouring Stencil
Material: PP.
Size: 15,5 x 7 cm

37229 ~~£3.00~~
£1.49

FEEL YOUR CONFIDENCE UNLEASHED

Wearing make-up boosts self-esteem. Use this surprising emotional benefit to make your day better! Enhance your best features with the contouring kit and stencil and create a customised set of your beloved eye shadows that will draw all the gazes on you!

THE ONE STOCKHOLM



Compact sold without eye shadows.

Craft your perfect palette!



Choose your favourite shades to add and hold them in place with Pro Magnet Click. Replace and refill whenever you like!

① THE ONE Make-up Pro Palette
15.1 x 5.5 cm.

40837 ~~£13.00~~
£7.99

Eye Shadow

- Highly pigmented
- Infused with Argan Oil and Vitamin E.
- Wet & Dry technology & application.

② THE ONE Make-up Pro Wet & Dry Eye Shadow
2.28g Merch price/g: £1.53

£7.00
£3.49



33673
Crisp Silver Shimmer

33675
Sandy Gold Shimmer

33678
Dusky Rose Shimmer

33681
Raw Copper Shimmer

33687
Base Nude Matte

34790
Golden Khaki

34792
Pewter Grey



42558
Sorbet Pink Matte

42559
Fizzy Orange Shimmer

42560
Electric Rose Shimmer

42561
Radiant Bronze Shimmer

42562
Fudge Brown Matte

42563
Dim Burgundy Matte



FEEL FLAWLESSLY BEAUTIFUL IN YOUR SKIN

Glow every day with Pure Uforia, a foundation designed to make your skin happy. Add a silky soft touch of Giordani Gold Brush for luxurious application and enjoy splendid results that you can both see and feel.

LIMITED EDITION



Helps to build up coverage and achieve a flawless finish.

① Giordani Gold Silky Foundation Buffer
15cm x 1.7 cm x 2cm. Materials: Aluminium, Nylon, Bamboo.

30887 ~~£13.00~~
£8.99



HydraBlend designed to hydrate beneath the surface of the skin.

② Giordani Gold Pure Uforia Foundation
30ml Merch price/10ml: £4.33

~~£21.00~~
£12.99



42360
Porcelain

42361
Ivory

42362
Vanilla

42363
Beige

42364
Golden Sand

42365
Almond

42366
Amber

42367
Caramel



FEEL THE HEATED THRILL

The perfect couple scents bonded by the aphrodisiac Sweet Pimiento accord. Soft and sensual for her, strong and spicy for him, So Fever Together fragrances echo ideally with the seduction game, adding to it a sparkle of desire.



ORIENTAL - SPICY - FOUGERE

Bergamot oil, Patchouli,
Sweet Pimiento



HIGH FRAGRANCE
CONCENTRATION

SO FEVER
TOGETHER HIM
FOR HIM

SO FEVER
TOGETHER HER
FOR HER



ORIENTAL - FLORAL

precious sandalwood, red currant
sorbet, sweet pimiento accord



VERY HIGH FRAGRANCE
CONCENTRATION

① So Fever Together Him
Eau de Toilette

75ml
Merch price/100ml: £23.99

35531 £28.00

② So Fever Together Her
Eau de Parfum

50ml
Merch price/100ml: £35.98

42835 £28.00

EACH FOR
£17.99

FEEL LIKE IN A BLOOMING GARDEN

Immerse yourself in the richness of sensual experiences offered by nature. Oriflame Collections bring you floral, woody and citrus scents skillfully crafted into enchanting fragrance masterpieces.



① Men's Collection Dark Wood Eau de Toilette
75ml
Merch price/100ml: £19.99
42518 ~~£22.00~~

② Men's Collection Citrus Tonic Eau de Toilette
75ml
Merch price/100ml: £19.99
30058 ~~£22.00~~

③ Oriflame Women's Collection Powdery Mimosa Eau de toilette
75ml
Merch price/100ml: £19.99
38514 ~~£26.00~~

④ Oriflame Women's Collection Radiant Peony Eau de toilette
75ml
Merch price/100ml: £19.99
38521 ~~£26.00~~

Buy 1 for
£14.99

Buy any 2
for only

£12.99
each



FEEL YOUNG AT ANY AGE

Boost your skin care with potent actives to target specific seasonal needs of your skin and raise your favourite NovAge range's efficiency. Enjoy the application of sumptuous formulations and the beautiful effects.



PRIMING ESSENCE
Works to **diminish the look of pores** and stimulates **natural cell renewal process** - thanks to the power of Marine Prebiotic.

PEPTIDE AMPOULES

Reduce wrinkles and firm skin by **boosting collagen production** with 0.5% Multi-peptide solution. **Instantly and effectively lift skin** thanks to 4% Tensor Mesh Active.

① **NovAge Skin Priming Essence**
150ml Merch price/100ml: £9.99
~~33987 £21.00~~
£14.99

② **NovAge ProCeuticals Instant Peptide Ampoules**
One-week course, 7 ampoules x 1.8 ml.
Merch price/10ml: £26.18
~~40880 £50.00~~
£32.99



FEEL THE POWER OF NATURAL INGREDIENTS

BEAUTANICALS

8 Essential Minerals + Botanical Extract

FORMULATED WITHOUT PARABENS AND SILICONES

Driven by the proven powers of natural ingredients, Beautanicals offer effective and responsible formulations with minerals and botanical extracts that bring you authentic beauty solutions.



① Beautanicals Revitalising Soap Bar
100g Merch price/100g: £2.49
35889 £4.50
£2.49

FRAGRANCED SHOWER GEL
formula cleanses, hydrates and revitalises your skin.



① Beautanicals Revitalising Body Cleanser
300ml
Merch price/100ml: £3.00
35892 £13.00
£8.99

BODY LOTION
Infused with nourishing oils leaves your skin lustrous and soft. Delivers 48-hour moisturisation.



② Beautanicals Restoring Oil Intense Body Lotion
200ml
Merch price/100ml: £4.50
42673 £13.00
£8.99

NEW!



REGISTERED WITH THE VEGAN SOCIETY™



95% NATURAL ORIGIN INGREDIENTS*

*Hand salve, soap bar and conditioner



BIODEGRADABLE FORMULAS**

**For all rinse-off formulas

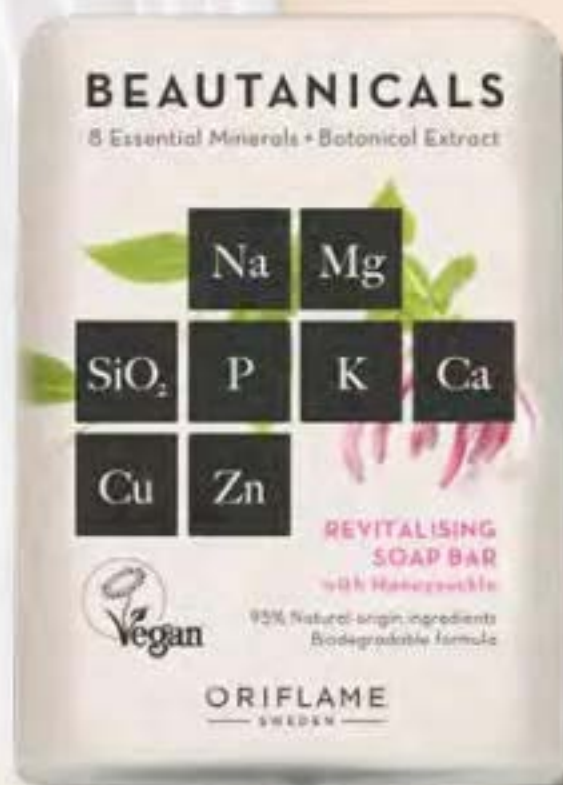

SET OF 2
OIL INTENSE BODY LOTION
+ BODY CLEANSER
ONLY
£12.99
 SET CODE 143944

Let's celebrate!



Always in style

For 55 years we've been tuning timeless fragrance classics to fit your unique, elegant style. Experience the most refined level of Parisian charm with the perfume for a man whose perfection comes naturally.



WOODY - AROMATIC -
AMBERY

Grapefruit, De Laire Sellier
Accord, Vetyver



MAXIMUM FRAGRANCE
CONCENTRATION

Eclat Style Parfum
75ml Merch price/100ml: £43.99

34522 ~~£49.00~~
£32.99



See the special offer
on the next page



BUY ECLAT STYLE PARFUM FOR

£32.99

AND GET 2 SAMPLES

FOR FREE*

*AUTOMATICALLY ADDED



TRY IT, LOVE IT!

TRY THEM NOW AND BUY REGULAR SIZE
IN NEXT CATALOGUE

① Waunt Woke Up Like This
Skin Retoucher SACHET
1.5ml

② Elvie Eau de Toilette Vial
1ml

KICK-START THE NEW SEASON

NEW!
LIMITED EDITION



Made from water-based PU - better for the environment!

Vibrantly coloured lining

Zipped pockets at the front and inside



① Back to Work Backpack

Water-based PU, polyester, EVA, zinc alloy, iron. L:28 x W:14 x H:36 cm.

45539

£36.99

KEEP YOUR EARPODS PROTECTED

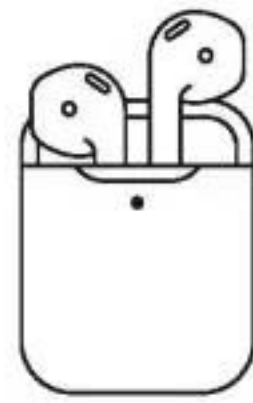

Earpods are not included.

Crafted in silicone - more durable than plastic.



Special slot for charging



② Earpods Case

Silicone. H:5.5 x L:4.7 x W:2.8 cm. Compatible with Airpods 1 and 2.

45545

£6.99

GREEN SNAKESKIN AND ROSE GOLD - A BOLD ADDITION TO ANY LOOK

NEW!
LIMITED EDITION



Comes in an elegant packaging - ready to be gifted!



③ Fulminare Women's Watch

Zinc alloy, glass, brass, stainless steel, PU. Seiko movement. Case diameter: 4 cm. Total length: 24 cm

45281

£34.99

EYEBROW RAZORS

LIMITED
EDITION

① Eyebrow Razor 2-Pack

Size: 14 x 1.5 cm, Materials:
50% Recycled Plastic,
Stainless Steel and Nylon

42468

£3.99



Shape your eyebrows.

First pluck between-brow hairs, then remove stray hairs that grow outside the natural shape of your brows.

PRECISION TWEEZER

② Precision Tweezer

Stainless steel. Size:
L9xW0.8cm.

42292 £4.00

£1.99

COLOUR, TAME AND SCULPT

- Contains nourishing, natural origin avocado oil.
- Volumises and intensifies your eyebrows.*
- Waterproof, sweat and humidity resistant.*

*Consumer Tested.



Heart shaped fibres



THE ONE Browcara

5ml Merch price/10ml: £9.98

£8.00

NOW FOR ONLY

£4.99



DRAMATIC EYE LOOK without drama!

DRAMATIC PIGMENT & PRECISION

- Designed for lasting wear thanks to **polymer technology**
- **Intense jet black** colour for dramatic impact
- Jumbo pen format gives **total control and precision** with every application

① THE ONE Eyeliner Stylo Jumbo
2.5g Merch price/g: £2.80

£10.00
£6.99

② THE ONE Lash Extension Mascara
8ml Merch price/10ml: £9.99

£11.00
£7.99



EXTREME LENGTH AND LIFT

• Up to
65%
longer and more lifted lashes^Δ

^ΔClinically Tested

- Dual-holed sharpener for lip and eye pencils ensures their best performance.

③ Dual Pencil Sharpener
Size: 3.5 x 2.8 x 2.5 cm.

27730 ~~£3.50~~
£2.49



Made You Look!

CURATED EYESHADOW QUADS

- **HIGHLY PIGMENTED** formula.
- With **POWDER-TECH** Complex designed for **LONG LASTING** wear.



LIMITED EDITION

① Eyeshadow Shield
Size: L 6.6cm x W 4.7 cm.

44765 ~~£3.95~~



NEW!
LIMITED EDITION

Add water FOR MORE INTENSE LOOK!

② THE ONE Make-Up Pro Eyeshadow Quad
6.4g Merch price/10g: £18.73

£17.00
£11.99

NEW!
LIMITED EDITION

SHOW-STOPPING HOLOGRAPHIC GLOW!

- Dropper format for easy application
- Illuminates skin with a beautiful, silvery pink glow
- Easy to mix with moisturiser, primer or foundation



THE ONE Illuskin Liquid Reflector
15ml Merch price/10ml: £5.33
40849 ~~£14.00~~
£7.99

SEE HOW IT WORKS!

HOLOGRAPHIC PEARLS

A performing blend of three holographic pearl powders with a unique colour-transforming effect create a highly reflective glow. The multi-layered finish shifts from silver to pink/purple upon application and in the light to illuminate your skin with an irresistible iridescent glow!

NAIL YOUR NAIL CARE



Smooth the edges with the nail file. Use side 2 to eliminate rough surface, and sides 3&4 to make your nails shine.



3-IN-1 SHIELD ACTION

- ACETONE FREE

Trim cuticles and rough areas around nail.

Wide, curved handles for precision nipping.

① **Nail It Nail File And Buffer**
Material: Polyester & Sandpaper
Size: 17.8 x 2 x 1.5cm

42289 ~~£4.00~~ **£2.99**

③ **Professional Manicure Kit**
ABS, EVA, metal.
Main tool L16.3 x W2.5 x H2.7cm.

44774 ~~£22.00~~
£17.99

② **THE ONE Pro Wear Priming Base Coat**
8ml Merch price/10ml: £7.49

37907 ~~£9.00~~ **£5.99**

④ **THE ONE Expert Care Fast & Gentle Nail Polish Remover**
75ml Merch price/100ml: £7.99

38722 ~~£8.00~~ **£5.99**

⑤ **Nail It Cuticle Nipper**
Material: Stainless Steel.
Size: 9 x 4.5 x 0.5cm

42287 ~~£8.00~~ **£5.49**

PERFECT MATTE MAKE-UP IN 4 STEPS!

1 PREPARE THE BASE

Prepare your face by mattifying it and getting the oil under control, which will extend your foundation's wear.



2 FULLY COVER IMPERFECTIONS

Use each shade of the correctors alone or custom-blend to suit your skin concern or skin tone, then blend the foundation on top!



3 CONTOUR & COLOUR

Use these versatile face stylers with interchangeable shades to highlight or add dimension to eyes, lips and cheeks.



4 SPRITZ & FIX

Give your face a couple of spritzes, first in an X formation and then in a T formation, to hold your look in place all day long.



• Long lasting **MATTE EFFECT.***



With green tea to minimise the appearance of oil and shine.

*Consumer Tested
 ② **The One Make-up Pro Primer Anti Shine**
 30ml
 Merch price/10ml: £2.33

• **FULL COVERAGE.***
 • **LONG WEAR.***



*Consumer Tested



③ **THE ONE Corrector Kit**
 3.9g
 Merch price/g: £3.07
 £16.00 **£11.99**

• **HIGH-MATTE FINISH** that lasts all day.*



*Consumer Tested

43368 Vanilla Nude	43369 Porcelain	43370 Light rose	43371 Beige Nude
43372 Ivory Nude	43373 Beige warm	43374 Golden Beige	43375 Caramel

④ **THE ONE Make-up Pro All Cover Stick Foundation**
 9g Merch price/10g: £13.32
 £16.00 **£11.99**

• **MULTI-PURPOSE** sticks to bronze, highlight, contour and blush your lips, eyes and face



- ① 36139 Shining Star
- ② 36140 Stunning Rose
- ③ 36141 Dazzling Brown
- ④ 36142 Hot Chocolate

43337 Sun-kissed Pink

LIMITED EDITION

① **THE ONE Face Styler Contour**
 6g
 Merch price/10g: £16.65
 £15.00 **£9.99**

② **THE ONE Face Styler Blush**
 6g
 Merch price/10g: £16.65
 £15.00 **£9.99**

• **SETS MAKE-UP IN PLACE FOR UP TO 12 HOURS** without melting, fading or settling into fine lines.*

*Consumer Tested



• **MASK PROOF YOUR MAKE UP:** formula is designed to reduce transfer while wearing a mask.

③ **THE ONE Make-Up Pro Face Mist**
 45ml Merch price/100ml: £17.76
 44008 £12.00 **£7.99**

• Leaves skin **FRESH, MATTE AND SHINE-FREE.**



① **Blotting Roller**
 ABS, PP, natural volcanic stone. 7 x 3cm.
 45068 ~~£13.00~~
£8.99

Get that soft-focus effect

LUMINOUS OIL FREE
FRESH FINISH

- SMOOTHS skin texture
- Designed to CONTROL OIL
- Creates HEALTHY LOOKING RADIANCE



① **THE ONE Illuskin Pressed Powder**
10g Merch price/10g: £8.99

£13.00
£8.99

② **THE ONE Foundation Brush**
FSC®-certified wood handle, Aluminium ferrule, PBT bristles. 15x3cm.

42478 ~~£9.00~~
£5.99

③ **THE ONE Powder Brush**
FSC®-certified wood handle, Aluminium ferrule, PBT bristles. 18x4cm.

42474 ~~£9.00~~
£5.99

④ **Powder Makeup Sponge**
Material: PU with PET coating. Size: 4x5 cm

42472 ~~£5.99~~
£4.49

THE ONE
STOCKHOLM

LIMITED EDITION

FOUNDATION BRUSH

POWDER BRUSH

TECH STORY - ULTRA FIX TECHNOLOGY

Ultra Fix Technology locks in a higher-fix layer of colour onto the lips to ensure it stays put exactly where you left it.

Set and forget

MATTE LIPS

- Clinically proven **99% FIXATION ON LIPS^A**

^AClinically Tested

- Up-to **8 HOURS** long lasting wear*

*Consumer Tested



① **THE ONE Colour Unlimited Ultra Fix Lipstick**
3.5g Merch price/g: £2.57

~~£12.00~~
£8.99

② **Squared Pocket Mirror**
ABS, Glass. 6.9cm x 6.9cm

37525 ~~£6.00~~
£3.99



A KISS OF SHEER PERFECTION



- Naturally matte, buildable coverage for perfection in seconds.
- Refillable compact for on-the-go application.

Presenting Cushion Foundation refill



The practical refill allows you to enjoy the foundation continuously and at your pleasure. Fresh radiance, always at hand!

① Giordani Gold Divine Touch Cushion Foundation Refill
12g Merch price/10g: £13.33

~~£24.00~~
£15.99

② Giordani Gold Divine Touch Cushion Foundation
12g Merch price/10g: £18.33

~~£32.00~~
£21.99



CUSHION FOUNDATION REFILL

38490 Natural Porcelain Warm	38487 Light Ivory Warm	38488 Sand Beige Cool	38489 Dark Beige Warm
---------------------------------------	---------------------------------	--------------------------------	--------------------------------

CUSHION FOUNDATION

37447 Natural Porcelain Warm	37444 Light Ivory Warm	37445 Sand Beige Cool	37446 Dark Beige Warm
---------------------------------------	---------------------------------	--------------------------------	--------------------------------



- 30,000 silky-thin hand cut fibres developed for a smooth finish and excellent product distribution.

③ Giordani Gold Silky Powder Polisher
12.3 x 2.3 cm. Materials: Aluminium, Nylon

30888 ~~£13.00~~
£9.99

NATURALLY FLAWLESS SKIN



42355
Light

42356
Medium

SPF 30 and UVA

protection to help protect against visible signs of ageing such as age spots, fine lines and wrinkles.

Skin feels plumped and moisturised for up to **10 hours***

**Consumer Tested*

Medium coverage and **natural finish.**

NEW!
LIMITED EDITION



① Giordani Gold Cream Caress SPF 30 + UVA Protection CC
40ml Merch price/100ml: £34.98

~~£20.00~~
£13.99

② Charcoal Infused Foundation Blender
PU, charcoal. 6 x 4 x 4 cm.

45726 ~~£5.99~~

Sponge infused with **charcoal**, known for its antibacterial properties

SUMPTUOUS SATIN LIPS IN ONE GLIDE



- Luminous satin finish thanks to Glow Illuminators.
- Long-lasting wear.
- SPF 15.

Giordani Gold Iconic Lipstick SPF 15
3.8g Merch price/g: £2.63

~~£14.00~~
£9.99

GET THE LASHES YOU ARE LOOKING FOR

Rich and intense colour definition in just one stroke
- 95% agree*

Smudge-proof - 88% agree.*

Accentuates Volume by **10x[†]**

- Infused with botanical origin Forget-me-Not Extract to help nourish and protect the lashes
- Intense black shade
- Soft, buildable formula
- Rich texture
- Feels like silk on the lashes.*

*Consumer Tested
†Clinically Proven.

② Giordani Gold Iconic Grand Mascara
8ml Merch price/10ml: £14.99

~~£16.00~~
£11.99



① Giordani Gold Liquid Eye Liner
3.2ml Merch price/ml: £2.81

~~£14.00~~
£8.99



③ Giordani Gold Eyelash Curler
Iron, rubber. L10xW6.2cm.

~~37449 £9.00~~
£5.99



LET YOUR EYES DO THE TALKING

Eyebrow Pencil

- Easy to shape, style & set brows
- Creamy, effortless glide
- Transparent, natural finish



MULTIPLE LASH MASCARA

- Multiple Bristle Brush with a tapered tip precisely coats even the smallest lashes



BIG LASH MASCARA

- Volumising Mascara designed for lasting wear.
- Pro-Vitamin B5 to help moisturise and condition.



MONO EYE SHADOW

- Easy-to-blend textures create the intensity you want



① OnColour Brow-To-Go Eyebrow Styling Pencil 1.12g Merch price/g: £3.56 ~~£6.00~~ ② OnColour Multiple Lash Mascara 8ml Merch price/10ml: £4.99 ~~£6.50~~ ③ OnColour Big Lash Mascara 8ml Merch price/10ml: £4.99 ~~£6.50~~ ④ OnColour Mono Eye Shadow 2g Merch price/g: £2.00 ~~£5.50~~

① OnColour Brow-To-Go Eyebrow Styling Pencil 1.12g Merch price/g: £3.56 ~~£6.00~~ ② OnColour Multiple Lash Mascara 8ml Merch price/10ml: £4.99 ~~£6.50~~ ③ OnColour Big Lash Mascara 8ml Merch price/10ml: £4.99 ~~£6.50~~ ④ OnColour Mono Eye Shadow 2g Merch price/g: £2.00 ~~£5.50~~

BUY ANY 1 FOR ONLY **£3.99**

BUY ANY 2 FOR ONLY **£2.99** EACH

BUY ANY 1 FOR ONLY **£3.99**

BUY ANY 2 FOR ONLY **£2.99** EACH

ENERGISE YOUR LOOK WITH FLAWLESS LOOKING SKIN



• Soothing Shea Butter that helps to nourish the skin.

- 38805 Light Porcelain
- 38806 Warm Ivory
- 38807 Natural Beige
- 38808 Dark Beige

① OnColour Power Up Foundation
30ml Merch price/10ml: £1.33

£7.00
£3.99



② Foundation Wedges 4-pack
Material: polyurethane. Size: 7.8 x 5 x 2.1 cm.

41560 ~~£3.50~~
£2.49

- Subtle coverage
- With nourishing natural peach oil
- With brightening Vitamin C



39292 Light

③ OnColour New Glow Perfector
30ml Merch price/10ml: £1.16

£6.00
£3.49

LIMITED EDITION

READY STEADY LOVE!

41731 Mad Red

41732 Frantic Cherry

41733 Fire Maroon



41729 Rose Pearl & Black



41730 Burgundy & Black

① OnColour Red Kiss Lipstick 4g
Merch price/10g: £7.48

£6.00
£2.99

② OnColour Duo Eye Pencil
1.6g Merch price/g: £1.87

£5.50
£2.99

MIX & MATCH THE COLOURS FOR VERSATILE EYE LOOKS



• 2 perfectly matched, complementary colours on 1 double-ended pencil.



36088 Mocha & Rose Gold



36089 Blue & Sapphire



36090 Green & Turquoise

③ OnColour Perfect Duo Eye Pencil
1.5g Merch price/g: £1.99

£5.50
£2.99

ESSENSE&CO
— STOCKHOLM 1967 —

Enjoy an uplifting feeling

Our luxurious bath & body
range infused with
natural essential oils



HERO INGREDIENTS

UPLIFTING LEMON & VERBENA

The delicate, citrusy aromas of
Lemon & Verbena marry perfectly,
bringing you a fresh, revitalising
dose of summer all year long.



**BEST
SELLER**

LOTION
with nourishing oils
softens skin

① **Essence&Co. Lemon &
Verbena Hand & Body Lotion**
300ml Merch price/100ml: £3.33

31851 ~~£16.00~~
£9.99

LIQUID SOAP
cleanses while also
moisturising

② **Essence&Co. Lemon &
Verbena Liquid Hand Soap**
300ml Merch price/100ml: £3.33

31850 ~~£15.00~~
£9.99



**SET OF 2
BODY LOTION +
LIQUID SOAP
ONLY**

£17.99

SET CODE 143946

Refresh your body with melon & coconut water

FRAGRANCE MIST

A dewy splash of refreshment!

SOAP BAR

Gentle formulation with **98% natural origin ingredients**



EXFOLIATING GLOVE

Gently removes dead skin cells while you shower
Made from **30% recycled material**



BIODEGRADABLE FORMULAS*



RECYCLED PLASTIC BOTTLES**

① Love Nature Refreshing Fragrance Mist with Organic Coconut Water & Melon
200ml Merch price/100ml: £4.00

43956 ~~£10.00~~
£7.99

② Love Nature Refreshing Soap Bar with Organic Coconut Water & Melon
75g Merch price/100g: £2.65

41489 ~~£2.50~~
£1.99

③ Elemental Exfoliating Glove
Size: L18,5xW16cm Material: Polyester

41593 ~~£7.00~~
£4.49

**Exact amount varies between 50 and 100%, and is clearly shown on each product
*All rinse-off formulas. At least 90% of "carbon-based" ingredients expected to be biodegradable in line with OECD guidelines or supplier data

Purify with green tea & cucumber

SHOWER GEL

Cleanses the skin, leaving it **purified and fresh.**



100% PCR Plastic Bottle



BIODEGRADABLE FORMULAS*



SOAP BAR

Cleans and leaves a crisp scent



Natural origin ingredients



① Love Nature Purifying Shower Gel with Organic Green Tea & Cucumber
250ml Merch price/100ml: £1.60

41280 ~~£5.00~~
£3.99

② Love Nature Purifying Soap Bar with Organic Green Tea & Cucumber
75g Merch price/100g: £2.65

41281 ~~£2.50~~
£1.99

Energise your skin with mint & raspberry



EXFOLIATING SOAP BAR

Cleanses and smooths the skin

③ Love Nature Energising Exfoliating Soap Bar with Organic Mint & Raspberry
75g Merch price/100g: £2.65

41277 ~~£2.50~~
£1.99

Combat oily hair once and for all

With natural organic extracts of lemon and mint



CONDITIONER
Lightly conditions oily hair to leave it feeling soft and easy to brush.



SHAMPOO
Helps clarify oily hair, leaving it feeling refreshed and non-greasy.

① Love Nature Shampoo For Oily Hair with Organic Lemon & Mint
250ml
Merch price/100ml: £1.60
41354 £5.00
£3.99

② Love Nature Conditioner For Oily Hair with Organic Lemon & Mint
250ml
Merch price/100ml: £1.60
43624 £5.00
£3.99

Let nature replenish your dry or damaged hair

With natural organic wheat and coconut oil

SHAMPOO
Effectively cleanses and helps bring the moisture back.



④ Love Nature Shampoo For Dry Hair with Organic Wheat & Coconut
250ml Merch price/100ml: £1.60
41295 £5.00 **£3.99**

③ Love Nature Conditioner For Dry Hair with Organic Wheat & Coconut
250ml Merch price/100ml: £1.60
41292 £5.00 **£3.99**

⑤ Love Nature Nourishing Hair Oil Coconut Oil
100ml Merch price/100ml: £4.99
41568 £8.00 **£4.99**

OVERNIGHT HAIR OIL
Replenishes and moisturises



CONDITIONER
Intensively conditions and nourishes hair, leaving it feeling soft and strong.

All hair types deserve natural nourishment!

With natural organic avocado oil and chamomile



NOURISHING HAIR MASK
Deeply nourishes and conditions with vitamins and fatty acids from avocado oil.

① Love Nature Nourishing Hair Smoothie Mask with Organic Avocado
30ml Merch price/10ml: £0.33
43154 £2.00 **£0.99**

② Love Nature 2-in-1 Shampoo For All Hair Types with Organic Avocado Oil & Chamomile
250ml Merch price/100ml: £1.60
41360 £5.00 **£3.99**

③ Love Nature Shampoo Bar Avocado Oil & Chamomile for Normal Hair
75g Merch price/100g: £6.65
39530 £9.00 **£4.99**



SHAMPOO BAR
Delicious natural goodness in one smart shampoo bar

LIMITED EDITION

2 IN 1: SHAMPOO AND CONDITIONER
Gently cleanses and conditions all hair types in one step.



NEW!

UNISEX

Hair fall control you can count on

Non-sticky, non-greasy hair spray intensively boosts hair volume to leave it fuller and healthier-looking.

Unisex scalp tonic helps stimulate hair growth at the roots and prolong hair life cycle for anti-hair loss effect in only 8 weeks!*

*Clinical testing performed to assess the anti-hair loss effect of the shampoo and scalp tonic used together.



① HairX Advanced Care Fall Defence Anti-Hairfall Hair Amplifier
150ml Merch price/100ml: £3.99
~~41980 £9.00~~
£5.99

② HairX Advanced Care Fall Defence Anti-Hairfall Scalp Tonic
100ml Merch price/100ml: £5.99
~~41979 £9.00~~
£5.99

Instantly refreshed, shiny, bouncy hair!



① HairX Advanced Care Volume Lift Dry Shampoo
150ml Merch price/100ml: £3.99
~~42890 £8.00~~
£5.99



Supreme treatment for damaged hair

NOURISHING SPLIT ENDS SERUM

- Helps to smoothen, soften and nourish the hair
- Helps to improve the manageability of damaged hair
- Helps to visibly reduce the appearance of split ends
- Dermatologically tested

HOW TO USE

1. Pump a coin-sized amount of serum into your hand.
2. Rub your hands together to distribute the serum evenly.
3. Work through towel dried hair, from mid-way down to the ends, avoiding the roots.



② HairX Advanced Care Ultimate Repair Nourishing Split Ends Serum
30ml Merch price/10ml: £2.00
~~42889 £10.00~~
£5.99

FOR COLOURED HAIR

Keep colour brighter, bolder – longer

Shampoo cleanses and softens while protecting hair colour from fading.

Conditioner helps seal-in colour pigments to preserve colour depth and shine.



① HairX Advanced Care Colour Revitalise Caring Shampoo
250ml Merch price/100ml: £2.00
~~45400 £7.00~~
£4.99

② HairX Advanced Care Colour Reviver Caring Conditioner
200ml Merch price/100ml: £2.50
~~32885 £7.00~~
£4.99

Cleanse and control a dry, flaky scalp



HERO INGREDIENT

Anti-Dandruff Shampoo contains **Sea Kelp** to lock in moisture and Minerals for healthy hair and scalp.



③ HairX Advanced Care Dandruff Solution Control Shampoo
250ml Merch price/100ml: £2.00
~~32893 £7.00~~
£4.99

Style your hair like a pro!



② **Styler Big Round Brush**
Size: L 22 x W 8.8 cm. Materials: ABD and Nylon

~~30609 £9.00~~ **£5.99**

③ **Styler Small Round Brush**
Size: L 22 x W 4.5 cm. Materials: ABS and Nylon

~~30595 £7.00~~ **£4.49**

④ **Styler Cushion Brush**
Size: L 24 cm x W 6 cm. Materials: ABS, Rubber and Nylon

~~30579 £7.00~~ **£4.49**

⑤ **Styler Detangle Brush**
Size: L 12,4 x W 7 x H 4,9 cm. Materials: PS, PP, PE, PET.

~~29998 £8.00~~ **£5.49**

Wake up to shiny, healthy hair

Hair feels repaired after a night's sleep* –

97% agree

*Consumer tested

HOW TO USE

1. Rub a few drops between your palms.
2. Distribute evenly throughout your damp or dry hair. Do not rinse.



① **Eleo Repairing Overnight Hair Oil**
Supremely nourishing hair oil for overnight repairing treatment. Infused with Eleo Golden Elixir and Camellia oil. 50ml
Merch price/100ml: £19.98

~~38602 £15.00~~
£9.99

YOUR EVERYDAY TRUSTED FEMININE CARE

PROTECTING INTIMATE WASH

- Helps protect from unpleasant odour & discomfort
- With cranberry extract to help protect skin
- With Lactic acid for optimal pH balance

① **Feminelle Protecting Intimate Wash Cranberry**

300ml
Merch price/100ml: £1.16

34498 ~~£6.00~~
£3.49

**BEST
SELLER**



EXTRA SOOTHING INTIMATE CARE

- With aloe vera & mallow extracts to help soothe skin
- With Lactic acid for optimal pH balance



**BEST
SELLER**

② **Feminelle Soothing Intimate Wash Aloe Vera & Mallow**

300ml
Merch price/100ml: £1.16

34499 ~~£6.00~~
£3.49

Clean, soft and protected hands on the go!

Protecting hand&nail cream helps restore hydration

150 ml

Nourishing hand cream relieves dryness and roughness

Cleanse gel helps reduce germs and bacteria

① **SoftCaress Protecting Hand Cleanse Gel** 50ml
Merch price/100ml: £5.98

42953 ~~£6.00~~
£2.99

② **SoftCaress Protecting Hand & Nail Cream** 150ml
Merch price/100ml: £3.33

31347 ~~£8.00~~
£4.99

③ **SoftCaress Nourishing Hand Cream** 150ml
Merch price/100ml: £3.33

31348 ~~£8.00~~
£4.99

Unwind with relaxing lavender scent



① **Scents & Moments Sweet Dreams Relaxing Soap Bar**
90g Merch price/100g: £1.10
39391 ~~£1.50~~ **£0.99**

Cocoon yourself in cosy almond blossom scent



② **Scents & Moments Soft Cuddles Caring Soap Bar**
90g Merch price/100g: £1.10
39397 ~~£1.50~~ **£0.99**

Complete protection for sensitive teeth

MEDIUM BRISTLE TOOTHBRUSH

96% agree*
Teeth, tongues, gums and cheeks feel deeply cleansed from day 1

*Consumer tested

② **Optifresh All In One Medium Toothbrush**
With silicone inserts and tongue cleaner pad.

42445 ~~£3.00~~
£1.99



With rubber tongue cleaner

SOFT BRISTLE TOOTHBRUSH

81% agree*
Teeth, tongue, gums and cheeks feel healthier

*Consumer tested

③ **Optifresh All In One Sensitive Soft Toothbrush**

42450 ~~£3.00~~
£1.99

SENSITIVE

Formulated with Desensitizing agent, which helps to shield nerve endings from irritants.

① **Optifresh Sensitive Toothpaste**
75ml Merch price/100ml: £3.99
38873 ~~£5.00~~
£2.99



**ORIFLAME
FOUNDATION**
EMPOWERING CHILDREN

Oriflame Foundation aims to empower children and young women by providing opportunities for them to change their lives for the better – to feel safe and protected. These values extend to our products, too.

By choosing them, you will also be supporting all the great work by the Oriflame Foundation.

MAXIMUM CARE IN HANDBAG SIZE

Have a hand cream ready to keep your hands beautifully soft and hydrated with sweet almond oil and glycerin.

HERO INGREDIENTS

Sweet almond oil:
Naturally hydrating, with a delicate lovely fragrance.

Glycerin:
Light and lubricating, Glycerin helps trap moisture and is perfect for sensitive skin.



Oriflame Dream Cream
30ml Merch price/10ml: £0.50
21878 ~~£3.50~~

£1.49

feet up
ADVANCED

ADVANCED FOOTCARE TO TARGET YOUR NEEDS

LARGE FILE

with curved shape helps gently remove cracked, dry skin.

DOUBLE-SIDED



DEO FOOT & SHOE SPRAY

HELPS CONTROL WETNESS & ODOUR DEVELOPMENT
36-HOUR odour control^A

^AClinical test.

RINSE-OFF FOOT SCRUB

DEEPLY EXFOLIATES & PURIFIES DRY, ROUGH SKIN
SMOOTHES AND SOFTENS SKIN

HOW TO USE

Massage Exfoliating Foot Cream into clean, dry skin using a circular motion, concentrating on the driest areas like the heels, toes and balls of the feet. Rinse off thoroughly with warm water.

① Advanced Foot File
Size: 23 x 6.5 cm. Material:
50% recycled PS, sandpaper

40781 ~~£8.00~~
£5.49

② Feet Up Advanced 36H Odour
Control Anti-perspirant Foot Spray
150ml Merch price/100ml: £5.99

33034 ~~£13.00~~
£8.99

③ Feet Up Advanced Deep
Exfoliating Foot Cream
75ml Merch price/100ml: £7.32

33033 ~~£9.00~~
£5.49



Lather
and Purify

Shower puff infused with charcoal to create rich lather and help remove impurities



Charcoal Shower Puff

Size: 11 x 11 cm. Materials: Puff:
50% recycled material, Polybag:
100% recycled material.

44005 ~~£4.00~~
£2.99

Burst of confidence

ACTIVELLE INVISIBLE FRESH

- 48h protection*
- Provides long lasting freshness**
- Anti-white marks**

ACTIVELLE COMFORT

- Up to 48h deodorant protection*
- A lightly floral yet cool scent



ACTIVELLE EXTREME

- Up to 72h deodorant control*
- Maximum protection even after physical activity**
- Powdery scent with fizzing citrus

*Clinically proven
**Consumer tested

① Activelles Invisible Fresh anti-perspirant deodorant spray
150ml
Merch price/100ml:
£2.33

41311 ~~£5.00~~

② Activelles Comfort Anti-perspirant Deodorant Spray
150ml
Merch price/100ml:
£2.33

33144 ~~£5.00~~

③ Activelles Extreme Anti-perspirant Deodorant Spray
150ml
Merch price/100ml:
£2.33

33147 ~~£5.00~~

EACH FOR

£3.49

Freshness pack

FEEL FRESH AND CONFIDENT ALL DAY LONG!

A perfect treat for all morning shower freshness fans. Keep this feeling for longer with the products from this set.



50% OFF

SET OF 4 DEO ROLL-ON + TOOTHPASTE + SHOWER GEL + FOOT CREAM ONLY

£8.99

SET CODE 143947

- ① 33142 Activelle Extreme Anti-perspirant Deodorant 50ml
Reg price/100ml: £6.00 **£3.00**
- ② 44952 Optifresh Maximum Fresh Toothpaste 100 ml
Reg price/100ml: £5.00 **£5.00**
- ③ 41264 Love Nature Refreshing Shower Gel with Organic Coconut Water & Melon 250ml
Reg price/100ml: £2.00 **£5.00**
- ④ 32368 Feet Up Comfort Anti-perspirant Foot cream 75ml
Reg price/100ml: £8.00 **£6.00**

SET OF 4
DEO ROLL-ON +
TOOTHPASTE + SHOWER
GEL + FOOT CREAM
ONLY
£8.99
SET CODE 143947

MAXIMUM FRESH
TOOTHPASTE

88% agree* on
intense freshness in
the whole mouth

*Consumer tested

REFRESHING
SHOWER GEL
cleanses the skin,
leaving it feeling
invigorated



DEO ROLL-ON
for a maximum of 72 hours of
sweat and odour control*

*Clinically proven.



DEODORISING
FOOT CREAM
gives instant
anti-perspirant
refreshment for
your feet

Luxe creamy moisture for skin and hair



HAIR MASK

Enriches hair with a deluxe nourishing blend for deep conditioning treatment



① Milk & Honey Gold Hair Mask for Radiant, Soft & Silky Hair
250ml Merch price/100ml: £2.40

35959 ~~£9.00~~ **£5.99**

SOAP BAR

Cleans the skin and leaves it hydrated and soft.



② Milk & Honey Gold Softening Creamy Soap Bar
75g Merch price/100g: £3.32

31604 ~~£3.50~~ **£2.49**

feet up COMFORT

A delicious summer treat for your feet

SMOOTHING FOOT CREAM

Glides over the skin, absorbs quickly and leaves feet feeling soft and nourished.



LIMITED EDITION

③ Feet Up Smoothing Pineapple & Ginger Foot Cream
75ml Merch price/100ml: £5.32

41899 ~~£10.00~~ **£5.99**

③ Feet Up Smoothing Pineapple & Ginger Foot Cream
75ml Merch price/100ml: £5.32

41897 ~~£6.00~~ **£3.99**

DEO FOOT & SHOE SPRAY

Helps combat unpleasant smell, leaving feet feeling fresh and cool. Suitable for use inside shoes.



LIMITED EDITION

② Feet Up Smoothing Pineapple & Ginger Foot Spray
150ml Merch price/100ml: £3.99

41899 ~~£10.00~~ **£5.99**

③ Feet Up Smoothing Pineapple & Ginger Foot Cream
75ml Merch price/100ml: £5.32

41897 ~~£6.00~~ **£3.99**

FOOT FILE

Gently buffs away dry, calloused skin



① Comfort Foot File
Size: 183L x 44W x 11Tmm. Material: Sandpaper, 50% recycled GPPS.

37559 ~~£6.00~~ **£3.49**



③ Festive Feet Heel Shields
Size: one size. 9cm L x 3cm W x 3mm T (2 pieces). Material: PU

41247 ~~£6.00~~ **£3.99**



④ Festive Feet Heel Cushions
Size: one size. 8.5cm L x 5cm W x 2.5mm T (2 pieces). Material: TPR

41244 ~~£6.00~~ **£3.99**

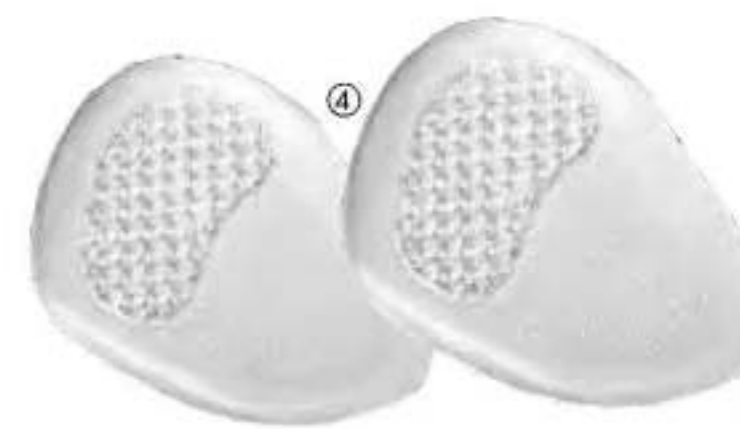

④ Festive Feet Foot Cushions
Size: one size. 9cm L x 6.5cm W x 2mm T (2 pieces). Material: TPR

41249 ~~£6.00~~ **£3.99**



⑤ Comfort Pedicure Toe Separators
Size: 100L x 28W x 9Tmm Material: Eva.

38337 ~~£2.50~~ **£1.99**



Baby care the way nature intended

95%
NATURAL
ORIGIN
INGREDIENTS

All Baby O' products are formulated without parabens, phenoxyethanol and formaldehyde releasers.

0+
MONTH

sensitive skin



PAEDIATRICIAN
ENDORSED

BODY OIL

Helps to nourish & replenish the skin barrier. Absorbs easily.

④ baby O Body Oil
150ml
Reg price/100ml: £8.67

35773
£13.00



HAIR & BODY WASH

Gel formula delivers a delicate foam that gently cleanses your baby's skin.

⑤ baby O Hair & Body Wash
200ml
Reg price/100ml: £4.50

35775
£9.00



① 35772 baby O Multi-Purpose Balm 75ml Reg price/100ml: £14.67 **£11.00**

② 35776 baby O BumBum Cleansing Milk 150ml Reg price/100ml: £8.00

£12.00 ③ 35774 baby O Diaper Cream 75ml Reg price/100ml: £14.67 **£11.00**

A SMART CHOICE

for a stylish man, these aviator shades will look equally handsome with a sharp suit as they will with a crisp white t-shirt.



LIMITED EDITION



① Archipelago Sunglasses
Stainless steel, PC, brass, AS plastic, recycled polyester. One size.

44340
£14.99

Featuring a pouch and a sleek box.

The legacy of manly elegance

The perfect balance of timelessness and modernity, this stately fragrance combines masculine allure with the essence of French luxury. An enduring scent, it is a refined mark of style for the contemporary gentleman.



BEST SELLER

① Eclat Homme Anti-perspirant Deodorant Spray
150ml Merch price/100ml: £2.99

31698 ~~£6.00~~
£4.49

② Eclat Homme Eau de Toilette
75ml Merch price/100ml: £26.65

42864 ~~£32.00~~
£19.99



ORIENTAL CITRUS WOODY
himalayan tea, leather accord,
tonka beans

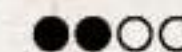

HIGH FRAGRANCE CONCENTRATION

Refreshingly sophisticated



WOODY CITRUS

Grapefruit, Bay, Cardamon



HIGH FRAGRANCE CONCENTRATION



ORIENTAL FOUGERE

Bergamot, Cardamom, Vanilla

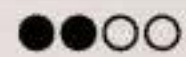

HIGH FRAGRANCE CONCENTRATION



① Flamboyant Eau de Toilette
75 ml. Merch price/100ml: £30.65

19639 ~~£32.00~~
£22.99

② Ascendant Eau de Toilette
75ml Merch price/100ml: £26.65

42490 ~~£28.00~~
£19.99



Lenses with UV 400 protection

LIMITED EDITION

Nordic Waters Sunglasses

Inspired by the aquatic world of Nordic Waters



Encased in a recycled polyester pouch that doubles as a convenient cleaning cloth.

③ Men's Nordic Waters Sunglasses

PC, stainless steel. Recycled polyester pouch. FSC paper box.

45256 ~~£18.99~~
£14.99

FEEL THE THRILLING FORCE OF NATURE



WOODY AROMATIC
Cascade Mint, Black Lemon, Vibrant Woods



HIGH FRAGRANCE CONCENTRATION



① Glacier Air Eau de Toilette
100ml Merch price/100ml: £16.99

38379 ~~£22.00~~
£16.99

② Glacier Fire Eau de Toilette
100ml Merch price/100ml: £16.99

42739 ~~£22.00~~
£16.99



AROMATIC TONIC
Grapefruit, Aquozone, Gaiac wood



HIGH FRAGRANCE CONCENTRATION

Buy any Glacier Eau de Toilette for **£16.99**
or buy any 2 for **£13.99** each

Go your own way



WOODY AROMATIC
Black Pepper, Lavandin,
Ambergris Accord

 SET OF 3
 EAU DE TOILETTE
 + BODY WASH
 + ROLL-ON DEODORANT
 ONLY FOR
£18.99
 SET CODE: 143948



① Be The Wild Legend
Eau de Toilette

75ml Merch price/100ml: £21.32

34471 ~~£26.00~~ **£15.99**

② North For Men Subzero
Hair & Body Wash

250ml Merch price/100ml: £1.80

35878 ~~£6.50~~ **£4.49**

③ North For Men Subzero
Deodorant Roll-on

50ml Merch price/100ml: £5.98

35880 ~~£4.00~~ **£2.99**



North For Men SubZero is formulated with Arctic Pro Defence technology, turbo charged with arctic ingredients and replenishing electrolytes to keep your skin quenched, invigorated and in peak condition.



ORIENTAL
FOUGERE

Pineapple,
Lavender,
Yew Wood

NEW!
LIMITED EDITION

① North For Men Intense
Fragranced Body Spray

100ml Merch price/100ml: £7.99

38913 ~~£10.00~~ **£7.99**

② North For Men PowerMax 2-in-1
Shaving and Cleansing Gel

200ml Merch price/100ml: £3.00

38612 ~~£9.00~~ **£5.99**

③ North For Men Subzero
Soap Bar

100g Merch price/100g: £2.49

35887 ~~£3.50~~ **£2.49**

1
CLEANSE

Deeply cleanses and purifies – 93% agree*



*Consumer tested on male skin.

① NovAge Men Purifying & Exfoliating Cleanser 125ml Merch price/100ml: £11.99

33198 ~~£20.00~~
£14.99

⑥ 35864 NovAge Men High Definition Shaving Gel 200ml Reg price/100ml: £9.50 ~~£19.00~~ ⑦ 35865 NovAge Men Soothing Aftershave Gel 100ml Reg price/100ml: £25.00 ~~£25.00~~

NOVAGE MEN

SKIN CONCERNS: Skin fatigue, wrinkles, dehydration and roughness

Recommended for ALL AGES



Supercharge your skin with Coffea Bengalensis Plant Stem Cell Extract and Baobab Anti-Ageing Technology

Your complete energising age-defence solution



⑤ NovAge Men SET Set of 4 full-size products. Merch price/10pcs: £197.50

29446 ~~£123.00~~
£79.00

① 33198 NovAge Men Purifying & Exfoliating Cleanser 125ml Merch price/100ml: £11.99 ~~£20.00~~ £14.99 ② 33199 NovAge Men Eye Rescue Gel 15ml Reg price/10ml: £18.67 ~~£28.00~~ ③ 33200 NovAge Men Energising & Hydrating Booster 50ml Reg price/100ml: £84.00 ~~£42.00~~ ④ 33201 NovAge Men Intense Anti-Ageing Face Gel Lotion 50ml Reg price/100ml: £66.00 ~~£33.00~~

Stay confident, in style

Our iconic fragrances also have their versions as roll-ons! Stay fresh and boost your confidence with your favourite scent!



ORIENTAL WOODY FRUITY
Leather, Apple, Tonka bean

① 34076 Be The Legend Anti-perspirant Roll-on Deodorant 50ml Merch price/100ml: £4.98 ~~£4.00~~ ② 42524 Mister Giordani Anti-perspirant Roll-On Deodorant 50ml Merch price/100ml: £4.98 ~~£4.00~~ ③ 42542 Glacier Anti-perspirant Roll-On Deodorant 50ml Merch price/100ml: £4.98 ~~£4.00~~

AROMATIC FOUGÈRE
Vetiver Top, Geranium, Grapefruit

AROMATIC FRESH
Citron, Geranium, Wood

EACH ROLL ON DEODORANT FOR ONLY

£2.49

ECLAT
Mon Parfum

Best kept secret of the fragrance world

Discover the scent with a legendary accord
from exclusive Parisian fragrance house.



HERO INGREDIENT

THE EXCLUSIVE DE LAIRE BOUDOIR ACCORD

Eclat Mon Parfum is one of the few fragrances in history to use a tailor-made legendary de Laire accord – a privilege only shared with such iconic brands as Chanel and Guerlain. De Laire Boudoir accord brings out the best notes of White Orris – the most prestigious flower in perfumery.



FLORAL GREEN

Nashi Pear, Almond Powder, de Laire
Boudoir Accord



MAXIMUM FRAGRANCE CONCENTRATION



① Eclat Mon Parfum
50ml
Merch price/100ml: £71.98
~~33957 £49.00~~
£35.99

② Eclat Mon Parfum
Purse Spray
8ml Merch price/10ml: £9.99
~~37769 £12.00~~
£7.99

Buy Eclat Mon Parfum and
get Purse Spray
FOR FREE*

*Automatically added

SET OF 3
EAU DE TOILETTE +
SHOWER GEL +
HAND CREAM
ONLY FOR
£17.99
SET CODE: 143949

SHOWER GEL
With pH balanced formula to
take care of your skin.

HAND CREAM
Leaves hands nourished and
beautifully scented.

Envelop yourself in beautiful scents



SET OF 3
EAU DE TOILETTE + SHOWER GEL +
HAND CREAM
ONLY FOR
£17.99

SET CODE: 143949

50%
off



ORIENTAL FLORAL
Green Pear, Solar Tiare Flower
Notes, Vanilla

① **Dare To Shine**
Eau de Toilette
50ml
Reg price/100ml: £56.00
42807 £28.00

LIMITED
EDITION

② **Splendid Bouquet**
Shower Gel
250ml Reg price/100ml: £2.40
42875 £6.00

③ **Splendid Bouquet**
Hand Cream
75ml Reg price/100ml: £6.00
42874 £4.50



FLORIENTAL -
FRUITY - SPICY
Plum, Black Pepper,
Sandal ağacı

●●○○
HIGH FRAGRANCE
CONCENTRATION

In the mood for romance

200 ml



① Loved Up Feel Good
Eau de Toilette
50ml Merch price/100ml: £23.98
~~37214 £16.00~~
£11.99

② Loved Up Shower Gel
Feel Good
200ml Merch price/100ml: £2.00
~~35993 £6.00~~
£3.99

FLORAL WOODY MUSK
Ginger, Peony, Tonka



Lost in You Eau de Parfum Her
50ml Merch price/100ml: £45.98
~~38508 £32.00~~ **£22.99**

FLORAL ROSE VIOLET
Rose Centifolia, Osmanthus, Iris



Volare Moments Eau de Parfum
50ml Merch price/100ml: £39.98
~~35661 £28.00~~ **£19.99**



LONG SILLAGE TECHNOLOGY

Divine Exclusive
Eau de Parfum

is tested and proven to leave
an unforgettable scent trail
over 5 meters long - for
ultimate star impact!

INSPIRED BY HAUTE COUTURE

Embellished with sparkling
Swarovski® crystals, the
glamorous bottle was inspired
by exquisite haute couture
dresses.

DIVINE
EXCLUSIVE

Shine like a star!

Emanate a radiance from
within with Divine Exclusive.
Created with the exclusive
Shining Star Accord, this
powerfully captivating
premium Eau de Parfum is
destined to leave an
unforgettable star impression.



FRUITY CHYPRE

Wild Strawberry, Shining Star Accord,
Patchouli Prisma

●●●○
VERY HIGH FRAGRANCE
CONCENTRATION



Divine Exclusive Eau de Parfum
50ml Merch price/100ml: £63.98

~~38498 £44.00~~
£31.99

Explore the depths of sensuality

Inspired by the mysterious depths of the Baltic Sea, Amber Elixir Crystal is the perfect spring to summer scent, fresh and distinctly sensual at the same time.



ORIENTAL FLORAL
nigella, baltic amber accord, brown sugar

●●●○
VERY HIGH FRAGRANCE CONCENTRATION



① Amber Elixir Crystal
Eau de Parfum
50ml Merch price/100ml: £43.98
42865 £34.00



AMBER ELIXIR CRYSTAL

Deep and shifting as the sea

A stunning collection that combines delicate, gold-toned shells with hand-set precious pieces of **natural Sodalite**. Admire the ever-shifting beauty of a stone as deep and mysterious as the Nordic sea.

N
Nörrsken



① **Ocean Sodalite Bracelet**
Brass, natural sodalite stones, Brass plating, Nickel safe, 25 cm.
43713 £17.99



② **Ocean Sodalite Earrings**
Brass, natural sodalite stones, titanium. Brass plating, Nickel safe, 3.5 x 1 cm.
43712 £9.99



③ **Ocean Sodalite Necklace**
Brass, natural sodalite stones, Brass plating, Nickel safe. Length: (short row) 48 + (long row) 54 + (extension) 7 cm.
43710 £21.99

Featuring a pouch and a sleek box.

SODALITE
This stone is thought to strengthen self-expression and to encourage intuition and balance.

LIMITED EDITION

£21.99

SET OF 3

bracelet + earrings + necklace only for

£34.99
SET CODE: 143950



UNIVERSAL ELEGANCE

In the chic, Scandinavian tradition simplicity is the core, and in the Musa collection you'll find modern classics that were given a stylish twist.

LIMITED EDITION

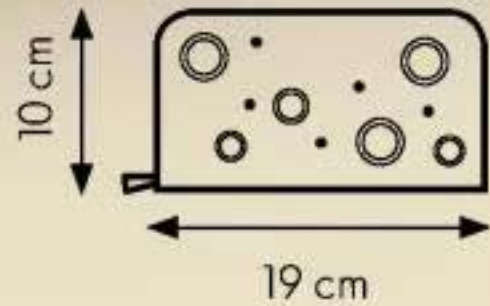

Musa Wallet
PU, recycled polyester, pp, nylon, zinc alloy, iron, brass.
L:19 x W:2 x H:10 cm.
41683 £20.95

Elegant refreshment

These roll-on deodorants are an indulgent and effective daily addition to enhance your perfume experience.

FLORAL FRUITY
WOODY

Sandalwood, Lily and Freesia, Violet

FLORAL ROSE VIOLET
Rose Centifolia, Osmanthus, Iris



FLORAL FRUITY

mango sorbet, neroli, red pondicherry peppercorn

- ① 41542 Divine Perfumed Roll-On Deodorant 50ml Merch price/100ml: £4.98 ~~£4.00~~
- ② 34079 Miss Giordani Perfumed Roll-on Deodorant 50ml Merch price/100ml: £4.98 ~~£4.00~~
- ③ 42740 Volare Moments Anti-perspirant Roll-on Deodorant 50ml Merch price/100ml: £4.98 ~~£4.00~~

Each roll-on deodorant for **£2.49**

KEEP YOUR FRAGRANCE CLOSE

See how your perfume develops throughout the day.

FLORAL WHITE FLOWERS
Jasmine Petals, Captive Musk Accord, White Woods

●●●●●
MAXIMUM FRAGRANCE CONCENTRATION

ORIENTAL VANILLIC
WOODY
Amber, Heliotrope, Mandarin

ORIENTAL
VANILLIC FRUITY

Ginger, Cocoa flower, Chocolate



LIMITED EDITION

FLORAL WATERY
calabrian bergamot, orange blossom luxury essenza, tuscan wood

- ① All or Nothing Unique Accord #1 Parfum 15ml Merch price/10ml: £7.99 ~~£12.00~~
43696 £17.00
£11.99

- ② 43662 Amber Elixir Eau De Parfum Purse Spray 8ml Merch price/10ml: £9.99 ~~£12.00~~
- ③ 40861 Love Potion Eau de Parfum Purse Spray 8ml Merch price/10ml: £9.99 ~~£12.00~~
- ④ 42786 Giordani Gold Essenza Parfum Purse Spray 8ml Merch price/10ml: £9.99 ~~£12.00~~

Each purse spray for **£7.99**

Essential substance that our bodies lack

Summer's slowly coming to an end, but that doesn't mean you can't cultivate all the good habits you've picked up! However, if you're coming back from seaside holidays, you might expect that your fish intake will probably decrease. How can you still get the benefits of seafood diet?



Omega 3

As our bodies do not produce Omega-3 fatty acids, they must be obtained from food sources or from supplements. Wellness by Oriflame Omega 3 provides you with the essential fatty acids that your body needs!



Rich in essential fatty acid EPA & DHA, Omega 3 is beneficial for supporting and maintaining the proper function of your brain**, heart*, and eyes**.

*The beneficial effect is obtained with a daily intake of 250 mg of EPA and DHA **The beneficial effect is obtained with a daily intake of 250 mg of DHA

**The beneficial effect is obtained with a daily intake of 250 mg of DHA



For our Omega 3 supplements, we only use pure, natural, pharmaceutical grade fish oil, certified sustainable by the association **Friend of the Sea (FOS)** - an independent organisation with a mission to conserve the marine environment while ensuring sustainable fish stocks.



Take 2 capsules per day with a meal.



Omega 3
60 capsules. 41.6g.
Merch price/100g: £28.84
29705 ~~£14.99~~

£11.99

Summer must-haves



① **29704 Multivitamin & Mineral woman** 60 tablets. 63.6g.
Reg price/100g: £25.14 **£15.99** ② **29703 Multivitamin & Mineral man**
60 tablets. 63.6g. Reg price/100g: £25.14 **£15.99**

Every 4th summer must-have below for FREE!*

*When subscribed to Wellness. Ask your Brand Partner for more information



③ **29696 WellnessPack woman** 21 sachets. 66.7g (21 x 3.17g).
Reg price/100g: £41.96 **£27.99** ④ **29697 WellnessPack man** 21
sachets. 66.7g (21 x 3.17g). Reg price/100g: £41.96 **£27.99**

Hair & Nail NutriComplex contains:

L-LYSINE and L-CYSTEINE
Building blocks of the protein keratin, the main component of hair and nails.

APPLE EXTRACT
Source of procyanidin B2, a type of flavonoid with antioxidant properties.

ZINC and SELENIUM
Contribute to the maintenance of normal hair and nails.

IRON
Contributes to normal oxygen transport in the body, which is essential for healthy hair and nails.

VITAMIN C
Contributes to the protection of cells from oxidative stress.

Take 2 tablets daily, over a course of 12 weeks. You can repeat the 12-week course again if needed, but take a 3 week break before starting again.



Summer hair & nail maintenance

The state of your hair and nails probably reflects how much fun you've had in salty water and in the sun. Now it's time to start them back on the road to full shine and strength!



Hair & Nail NutriComplex
42 tablets. 29.4g. Merch price/10g: £5.10
29706 £17.99

£14.99

Convenient & tasty, so you stay healthy!

Top up your energy levels with high-in-protein formulas designed to enhance your daily nutrition. From an unflavoured protein blend to mix with any food or beverage to delicious shakes you can take everywhere with you.

- NON-GMO PRODUCT
- GLUTEN FREE
- 21 SERVINGS



① Wellness Premium Container
14.5 x 11 cm.

27728 £12.99

② Wellness Shaker
Materials: PE, PP, stainless steel. BPA free. Size: 220 x 95 mm. 600 ml.

45381 £9.00

Every 4th Protein Blend or Shake for FREE!*

*When subscribed to Wellness. Ask your Brand Partner for more information



- ① 29689 Natural Balance Shake strawberry flavour 21 servings. 378g. Reg price/100g: £7.67 **£28.99**
- ② 29690 Natural Balance Shake vanilla flavour 21 servings. 378g. Reg price/100g: £7.67 **£28.99**
- ③ 29691 Natural Balance Shake chocolate flavour 21 servings. 378g. Reg price/100g: £7.67 **£28.99**
- ④ 36169 Protein Blend 378 g. Reg price/100g: £7.67 **£28.99**

Mix, store & carry your essentials easily

The Wellness Shaker is the perfect companion when you want to enjoy nutrition on-the-go. The practical and minimalist design offers capacity without compromise. Making healthy-living easy!



⑤ Wellness Smartshake Bottle
Size: 220 x 95mm, 600ml
Material: PP (bottle) and PE (lid) stainless steel (clip)
44622 £10.99

NEW!



- 1 Main compartment for liquid (600ml) easily mixes and holds your liquids
- 2 Middle compartment (140ml) safely stores supplements and snacks
- 3 Base compartment (200ml) for extra powder portions

3 stackable storage compartments, with removable organiser



- Mixer net, crushes powder easily for a lump-free drink
- Secure cap and lid ensure a leak-proof seal

Supplements offer vital health benefits



① 29688 Astaxanthin & Bilberry Extract 1 Month Supply. Reg price/10pcs: £6.00 **£17.99** ② 31766 Marine Calcium & Vitamin D 30 tablets. 45g. Reg price/10pcs: £4.00 **£11.99**

Every 4th product below for FREE!*

*When subscribed to Wellness. Ask your Brand Partner for more information



① 29695 Natural Balance Soup asparagus 21 servings. 420g. Reg price/100g: £6.90 **£28.99** ② 29694 Natural Balance Soup tomato & basil 21 servings. 420g. Reg price/100g: £6.90 **£28.99**



Why should you love WellnessKids Omega 3 and Multivitamins and Minerals?

Changing seasons is always the moment when a child's immune system is under the greatest strain. That is why it's important to make sure they are provided with a comprehensive list of nutrients.

Omega 3 is:

- high in omega 3 fatty acids and vitamin E
- supplies the fatty acids EPA and DHA that may be missing from the diet

WellnessKids Multivitamins and Minerals is:

- high in vitamins A, D, E, C, B1, B2, B3, B5, B6, B12, B7, K, folic acid and minerals iron, calcium, magnesium, selenium, zinc, iodine, chromium, molybdenum.



Every 4th WellnessKids product for FREE!*

*When subscribed to Wellness. Ask your Brand Partner for more information

Rich in health benefits

Childhood is a rapid stage of growth and children have high nutritional requirements relative to their body size. Depending on their age, specific nutritional requirements are required to support optimal growth and cognitive development.

From age 3: 1 teaspoon (5 ml) per day with a meal; consume directly or add to foods

Kids aged 3-9: 1 tablet per day, kids aged 10-14: 2 tablets per day



Fish oil flavoured with natural lemon oil

① **WellnessKids Omega 3**
For children ages 3+. 105 ml.
Reg price/100ml: £9.51

22467 £9.99



Chewable tablets with natural orange flavour

② **WellnessKids Multivitamins and Minerals**
21 tablets x 1.1g. Reg price/10g: £4.33

28241 £9.99

It's all about balance!

We believe in the synergy of a wholesome diet: adequate hydration, physical activities, and positive lifestyle choices work together to optimise your overall health and well-being.

This set reflects exactly such balance: Supplementation to help bridge the gaps in your nutrition and give your organism a boost; Shakes to snack smart and keep you on the healthy path.



1

Choose your favourite flavour of Wellness Shake or Protein Blend.

2

Choose the WellnessPack for women or men.



29690 Natural Balance Shake vanilla flavour 21 servings, 378g. Reg price/100g: £7.67 **£28.99** **29691 Natural Balance Shake chocolate flavour** 21 servings, 378g. Reg price/100g: £7.67 **£28.99** **29689 Natural Balance Shake strawberry flavour** 21 servings, 378g. Reg price/100g: £7.67 **£28.99** **36169 Protein Blend** 378 g. Reg price/100g: £7.67 **£28.99**

29696 WellnessPack woman 21 sachets, 66.7g (21 x 3.17g). Reg price/100g: £41.96 **£27.99** **29697 WellnessPack man** 21 sachets, 66.7g (21 x 3.17g). Reg price/100g: £41.96 **£27.99** **120229 Wellness Paper Bag** Size: 30 cm (H) x 30 cm (W) x 9 cm (L). **£1.50**

Get your customised Health & well-being set

£56.98

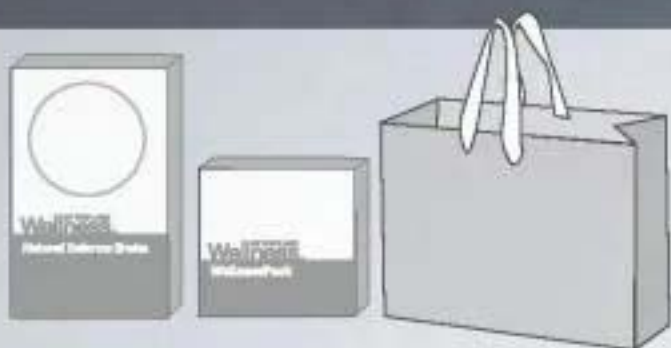

100

Every 4th set FREE*

*When subscribed to Wellness. Ask your Brand Partner for more information

Maximise your results!

Even if you reach your weight goals, maintaining them poses other challenges: preserving muscle growth, staying motivated, resisting temptations... Let this set give you a hand with that!

Natural Balance products come together with essential vitamins and minerals to help make fit lifestyle sustainable. Get ready to push your limits!



1

Choose your two favourite flavours of Wellness Shake or Soup or Protein Blend.

2

Choose the WellnessPack for women or men.



29695 Natural Balance Soup asparagus 21 servings, 420g. Reg price/100g: £6.90 **£28.99** **29694 Natural Balance Soup tomato & basil** 21 servings, 420g. Reg price/100g: £6.90 **£28.99** **29690 Natural Balance Shake vanilla flavour** 21 servings, 378g. Reg price/100g: £7.67 **£28.99** **29691 Natural Balance Shake chocolate flavour** 21 servings, 378g. Reg price/100g: £7.67 **£28.99** **29689 Natural Balance Shake strawberry flavour** 21 servings, 378g. Reg price/100g: £7.67 **£28.99** **36169 Protein Blend** 378 g. Reg price/100g: £7.67 **£28.99**

29696 WellnessPack woman 21 sachets, 66.7g (21 x 3.17g). Reg price/100g: £41.96 **£27.99** **29697 WellnessPack man** 21 sachets, 66.7g (21 x 3.17g). Reg price/100g: £41.96 **£27.99** **120229 Wellness Paper Bag** Size: 30 cm (H) x 30 cm (W) x 9 cm (L). **£1.50**

Get your customised Health & well-being set

£85.97



101

Every 4th set FREE*

*When subscribed to Wellness. Ask your Brand Partner for more information

SKIN CARE

55
TOGETHER
TOWARDS
TOMORROW

NEW!
LIMITED EDITION

LUXE EYE MASK

crafted in a lush floral print with a silky finish



SILKY FLORAL dream-come-true

SOFT SCRUNCHIE
gently holds your hair to minimise its breakage



The set comes in
A MATCHING DRAWSTRING POUCH

Summer Burst Sleep Mask and Scrunchie Set
100% recycled polyester. Eye mask: 20 x 9 cm. Pouch: 24 x 13 cm.

45327 **£12.99**

102

Blissful summer BEAUTY SLEEP

40+

For all skin types

Visibly younger-looking skin in

14 NIGHTS*

*Consumer tested



HOW TO USE

Apply **before sleep** for the overnight treatment. Use **every night**.

Diamond Cellular Night Restorative Treatment
30ml Merch price/10ml: £6.66
18437 **£32.00**

Night Restorative Treatment only

Also available

£19.99

103

YOUR ANTI-AGEING SKIN ULTRA-CALMER

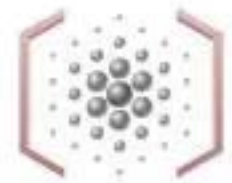

ULTRA CALM TECHNOLOGY

This natural active ingredient is present in all components of the Skinrelief range. It is obtained from the roots of *Ophiopogon Japonicus* and it works in multiple ways to:

- Optimise the skin barrier structure
- Restore hydration balance
- Soothe irritated skin
- Help rebalance skin's microbiome



to learn about
NovAge routine

NOVAGE ROUTINE STEPS

CLEANSE



Read more
about this step
on pages
xx-yy.

TARGET



BOOST



MOISTURISE

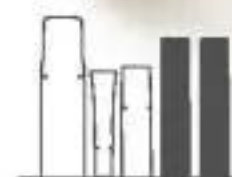
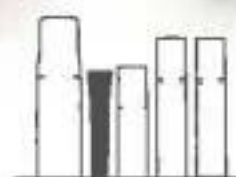
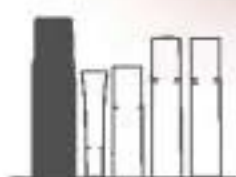

Recommended for ALL AGES

Reduces wrinkles by up to 23% in 8 weeks^{Δ1}

1ST Oriflame set clinically proven
to reduce skin sensitivity^{Δ1}

Δ1 Clinical test using NovAge Skinrelief Set - cleanser, eye cream, serum, day cream without SPF and night cream.



Hygienic
airtight pump
packaging

⑥

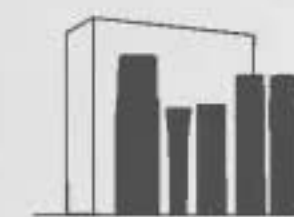

⑥ **NovAge Skinrelief Pro Resilient SET**
Set of 5 full-size products.

44480 ~~£157.00~~
£105.00

- ① 38382 NovAge Skinrelief Pro Resilient Foam Cleanser 150ml Reg price/100ml: £14.00 **£21.00**
- ② 38390 NovAge Skinrelief Pro Resilient Eye Cream 15ml Merch price/10ml: £14.66 ~~£28.00~~ **£21.99**
- ③ 38391 NovAge Skinrelief Pro Resilient Serum 30ml Reg price/10ml: £14.00 **£42.00**
- ④ 40794 NovAge Skinrelief Pro Resilient Day Cream SPF 30 50ml Reg price/100ml: £66.00 **£33.00**
- ⑤ 38385 NovAge Skinrelief Pro Resilient Night Cream 50ml Reg price/100ml: £66.00 **£33.00**

SKIN CONCERNS:
First signs of ageing, skin dullness

Recommended for 20+

Supercharge your skin with Taurine Energising Technology and Acai Plant Stem Cells Extract.

Skin radiance is improved 25x^{Δ2}



⑥ NovAge Skinerigise SET
Set of 5 full-size products.
Merch price/10pcs: £170.00

**42723 ~~£124.00~~
£85.00**



^{Δ2}Clinically tested, NovAge Skinerigise full routine, after 8 weeks' use.

① 33984 NovAge Supreme Cleansing Gel 150ml Reg price/100ml: £14.00 **£21.00** ② 34515 NovAge Skinerigise Ideal Perfection Eye Cream 15ml Merch price/10ml: £10.66 ~~£21.00~~ **£15.99** ③ 34517 NovAge Skinerigise Ideal Perfection Serum 30ml Reg price/10ml: £10.67 **£32.00** ④ 34511 NovAge Skinerigise Ideal Perfection Day Cream SPF 30 50ml Reg price/100ml: £50.00 **£25.00** ⑤ 35075 NovAge Skinerigise Ideal Perfection Night Cream 50ml Reg price/100ml: £50.00 **£25.00**

SKIN CONCERNS:
Visible wrinkles, fine lines and dryness

Recommended for 30+

Supercharge your skin with patented Tri-Peptide Technology, Low Molecular Weight Hyaluronic Acid and Edelweiss Plant Stem Cell extract.

Instantly reduces wrinkles by up to 49%^{Δ2}



⑥ NovAge Ecollagen Wrinkle Power SET
Set of 5 full-size products.
Merch price/10pcs: £210.00

**42489 ~~£157.00~~
£105.00**



^{Δ2}Clinically proven using the NovAge Ecollagen Wrinkle Power Set.

① 33984 NovAge Supreme Cleansing Gel 150ml Reg price/100ml: £14.00 **£21.00** ② 33979 NovAge Ecollagen Wrinkle Power Eye Cream 15ml Merch price/10ml: £14.66 ~~£28.00~~ **£21.99** ③ 33980 NovAge Ecollagen Wrinkle Power Serum 30ml Reg price/10ml: £14.00 **£42.00** ④ 42426 NovAge Ecollagen Wrinkle Power Day Cream SPF 35 50ml Reg price/100ml: £66.00 **£33.00** ⑤ 33982 NovAge Ecollagen Wrinkle Power Night Cream 50ml Reg price/100ml: £66.00 **£33.00**

^{Δ3}Clinically tested using full NovAge Ultimate Lift Set vs cleanser and day cream alone.



① 33984 NovAge Supreme Cleansing Gel 150ml Reg price/100ml: £14.00 **£21.00** ② 34552 NovAge Ultimate Lift Contour Define Eye Cream 15ml Merch price/10ml: £17.33 ~~£34.00~~ **£25.99** ③ 34550 NovAge Ultimate Lift Contour Define Serum 30ml Reg price/10ml: £17.00 **£51.00** ④ 34510 NovAge Ultimate Lift Contour Define Day Cream SPF 15 50ml Reg price/100ml: £80.00 **£40.00** ⑤ 34549 NovAge Ultimate Lift Contour Define Night Cream 50ml Reg price/100ml: £80.00 **£40.00**



⑥ NovAge Ultimate Lift Contour Define SET
Set of 5 full-size products.
Merch price/10pcs: £238.00

**44941 ~~£186.00~~
£119.00**

SKIN CONCERNS:
Loss of firmness and elasticity

Recommended for 40+

Supercharge your skin with Patented AspartoLift technology, Buddleja Plant Stem Cell extract and Patented Tri-Peptide Technology

Restores 40% lost elasticity in just 4 weeks!^{Δ3}

^{Δ3}Consumer test using the NovAge Time Restore Skin Care Set.
^{Δ1}Day and night cream.



① 33984 NovAge Supreme Cleansing Gel 150ml Reg price/100ml: £14.00 **£21.00** ② 32629 NovAge Time Restore Eye & Lip Cream 15ml Merch price/10ml: £17.33 ~~£34.00~~ **£25.99** ③ 32630 NovAge Time Restore Revitalising Serum 30ml Reg price/10ml: £17.00 **£51.00** ④ 32627 NovAge Time Restore Multi Correcting Day Cream SPF 15 50ml Reg price/100ml: £80.00 **£40.00** ⑤ 32628 NovAge Time Restore Regenerative Night Cream 50ml Reg price/100ml: £80.00 **£40.00**



⑥ NovAge Time Restore SET
Set of 5 full-size products.
Merch price/10pcs: £238.00

**31774 ~~£186.00~~
£119.00**

SKIN CONCERNS:
Deep wrinkles, loss of density and definition

Recommended for 50+

Supercharge your skin with Genistein^{SOY} Technology & Ribwort Plant Stem Cell extract^{Δ1}

Improved elasticity in mature skin 94% agree^{Δ1}

SKIN CONCERNS: hyperpigmentation, uneven, patchy skin tones

Recommended for ALL AGES

Reduces all major skin tone discolourations and dark spots in just 2 weeks*

*Consumer test.



⑥ NovAge Brilliance Infinite Luminosity Set

Set of 5 full-size products.
Merch price/10pcs: £210.00

44680 ~~£157.00~~
£105.00

- ① 33984 NovAge Supreme Cleansing Gel 150ml
Reg price/100ml: £14.00 **£21.00**
- ② 35746 NovAge Brilliance Infinite Luminosity Eye Cream 15ml Merch price/10ml: £14.66 ~~£28.00~~ **£21.99**
- ③ 34509 NovAge Brilliance Infinite Luminosity Serum 30ml
Reg price/10ml: £14.00 **£42.00**
- ④ 35744 NovAge Brilliance Infinite Luminosity Day Cream SPF30 50ml Reg price/100ml: £66.00 **£33.00**
- ⑤ 35745 NovAge Brilliance Infinite Luminosity Night Cream 50ml
Reg price/100ml: £66.00 **£33.00**



**BRUSH
CLEANSING
HEAD**



**SILICONE
EXFOLIATING
HEAD**



**METAL
MASSAGE
HEAD**

SkinPro Sonic 3-in-1 System

Device 15.8 x 5.8 x 5.8 cm, ABS. Brush Cleansing Head diameter 4.77 cm, PP and nylon bristles. Silicone Exfoliating Head, diameter 5 cm, PP and silicone. Metal Massage Head 6.1 x 5 cm, PP and stainless steel.

29915 ~~£52.00~~
£41.99



HOW TO USE

Apply the Serum morning and evening after finishing your NovAge routine to lift and firm your neck and décolleté.



Fine lines and wrinkles are minimised around neck and chest area – 88% agree*

*Consumer tested.

① NovAge Neck & Décolleté Advanced Sculpting Serum
75ml Merch price/100ml: £34.65
35076 ~~£36.00~~
£25.99



Visibly reduces signs of ageing like wrinkles and dark spots on hands

② Moisturizing Gloves With Touch
Material: Cotton, elastane, metalised fibre.
Size: 18,8 x 12,9 cm.

37607 ~~£8.00~~
£5.49



SPF

③ NovAge Intensive Age Defence Hand Cream SPF 25
50ml Merch price/100ml: £27.98
35073 ~~£18.00~~
£13.99

STEP
2
TARGET



Keep an eye on your skin's needs

The skin on lids and around the eyes is the thinnest and eye muscles are the most active of all in the human body. That is why **the eye area is the first to show signs of fatigue and ageing.** Treat it gently yet effectively with the right NovAge eye cream and see the beautiful results on your own eyes.



SKIN CONCERNS:
Sensitive, reactive skin,
signs of ageing

Soothes, cools and comforts the eye area instantly – **88% agree***

*Consumer test.

SKIN CONCERNS:
hyperpigmentation, uneven,
patchy skin tones

Visibly brightens the skin around the eye area^Δ

^ΔClinical test.

SKIN CONCERNS:
First signs of ageing,
skin dullness

Clinically proven instant and 24-hour hydration^Δ

^ΔStratum Corneum. Eye Cream alone, after first use.

SKIN CONCERNS:
Visible wrinkles, fine lines and dryness

Crow's feet wrinkles and lines are reduced*

*Consumer test.

SKIN CONCERNS:
Loss of firmness and elasticity

Significantly lifts the appearance of the eye contour*^Δ

^ΔConsumer tested with eye cream on a panel of 78 women.

SKIN CONCERNS:
Deep wrinkles, loss of density and definition

More defined eye contours **80%***

*Consumer test.



Use on the eyes and lips areas to re-densify skin, smoothe out deep wrinkles and diminish under-eye circles and puffiness.

<p>① NovAge Skinrelief Pro Resilient Eye Cream 15ml Merch price/10ml: £14.66 38390 £28.00 £21.99</p>	<p>② NovAge Brilliance Infinite Luminosity Eye Cream 15ml Merch price/10ml: £14.66 35746 £28.00 £21.99</p>	<p>① NovAge Skinergise Ideal Perfection Eye Cream 15ml Merch price/10ml: £10.66 34515 £21.00 £15.99</p>	<p>② NovAge Ecollagen Wrinkle Power Eye Cream 15ml Merch price/10ml: £14.66 33979 £28.00 £21.99</p>	<p>③ NovAge Ultimate Lift Contour Define Eye Cream 15ml Merch price/10ml: £17.33 34552 £34.00 £25.99</p>	<p>④ NovAge Time Restore Eye & Lip Cream 15ml Merch price/10ml: £17.33 32629 £34.00 £25.99</p>
------------------------------------------------------------------------------------------------------------------------------------	------------------------------------------------------------------------------------------------------------------------------------------	---------------------------------------------------------------------------------------------------------------------------------------	-----------------------------------------------------------------------------------------------------------------------------------	----------------------------------------------------------------------------------------------------------------------------------------	----------------------------------------------------------------------------------------------------------------------------------

NovAGE

BEAUTY BY SWEDEN MEANS BEAUTIFUL SKIN

We turn to nature for inspiration and innovate through science to bring you the best beauty results. **NovAge overnight mask** maximises your skin's natural ability to **regenerate at night** so that you can wake up to ultimately nourished and well-rested-looking skin.

HERO INGREDIENTS

Cupuaçu Butter

Rich in Oleic Acid and Phytosterols, nourishes and softens the skin while strengthening its barrier.

Hyaluronic Acid

Helps to reduce wrinkles and lock in moisture for better hydration.

Inca Inchi Oil

With Omega 3 to enhance skin's elasticity and Vitamin E to protect against free radical damage.

112



Intensively diminishes signs of
fatigue from the first use -
82% agree*²

*²Consumer test % agreement.

① SkinPro Mask Spatula
Length: 19 cm.

45276 ~~£7.00~~
£3.99

② NovAge Intense Skin Recharge
Overnight Mask
50ml Merch price/100ml: £39.98

33490 ~~£33.00~~
£19.99

113

PURE SKIN

Step up your CLEANSING GAME!

For oily, blemish-prone skin

SOS BLEMISH GEL

Reduces spot size and redness within 8 hours^Δ

Reduces the size of spots by 40% within 24 hours^Δ

Prevents spots from worsening within 24 hours^Δ

^ΔClinically tested

① Pure Skin SOS Blemish Gel
6ml Merch price/10ml: £11.65

41676 ~~£10.00~~
£6.99



② Double-Ended Blackhead Remover
Size: 0.7 x 11.5 cm.

26825 ~~£7.00~~
£3.99

FACE BRUSH

Remove every bit of make-up, sunscreen and everyday impurities to reveal a clear, bright and glowing skin.



③ Face Brush
4.5 x 2.5 cm.

38679 ~~£7.00~~
£4.49



114

LIMITED EDITION

Clear skin FROM TOP TO TOE!

3-IN-1 RED CLAY BAR CLEANSER:
CLEANSSES the skin of dirt and make-up
PURIFIES and unclogs the pores
EXFOLIATES to remove dead skin cells

NEW!



④ Pure Skin Headband
Size: 60x7 cm
60% recycled polyester
Adjustable to fit all sizes.

42447 ~~£5.99~~
£3.99



For daily use
ON FACE AND BODY

⑤ Pure Skin 3-in-1 Clear-Out Clay Bar Cleanser

75g
Merch price/100g: £5.99

44138 ~~£6.00~~
£4.49

115



ALL SKIN TYPES | Suitable for sensitive skin

Fuss-free skin care for the whole family!

Rich, nourishing texture that absorbs quickly



① Essentials Multi-Purpose Cream with Vitamin E & Canola Oil
150ml Merch price/100ml: £2.99

35767 ~~£6.00~~
£4.49

② Essentials Face Mask with Vitamin E & Canola Oil
10ml Merch price/10ml: £1.49

35765 ~~£2.00~~
£1.49

Paraben-free formula



No irritation, **JUST SMOOTHNESS.**

③ Facial Hair Remover
Size: Approx. 10,5x5 cm.
Stainless steel and plastic.

38495 ~~£11.00~~
£7.99



OPTIMALS

TWO STEPS to refreshed, purified skin



1. SCRUB

ALMOND SHELL GRANULES

Physically remove dirt, oil and make-up, help get rid of dead skin cells

2. PURIFY

CHARCOAL helps draw out impurities and minimise the look of pores

① Optimals Exfoliating Face Scrub
75ml Merch price/100ml: £10.65

42614 ~~£12.00~~ **£7.99**

② Optimals Purifying Clay Face Mask
50ml Merch price/100ml: £15.98

42615 ~~£12.00~~ **£7.99**

SET OF 2
EXFOLIATING FACE SCRUB
+ PURIFYING CLAY MASK ONLY

£11.99

SET CODE 143951

ALL AGES

For normal skin

Ready to refresh?

ALL AGES

For oily skin



REFRESHING TONER

Helps remove last traces of make-up

① Love Nature Refreshing Toner with Organic Aloe Vera & Coconut Water 150ml Merch price/100ml: £3.33

34820 ~~£7.00~~
£4.99

GEL WASH

Helps purify and instantly refresh skin



② Love Nature Purifying Gel Wash with Organic Tea Tree & Lime 125ml Merch price/100ml: £3.99

34841 ~~£7.00~~
£4.99



PURIFYING TONER

Helps minimise pores and leave skin toned and refreshed

③ Love Nature Purifying Toner with Organic Tea Tree & Lime 150ml Merch price/100ml: £3.33

34843 ~~£7.00~~
£4.99



2-IN-1 MASK & SCRUB

Works to make pores less visible

2-IN-1 MASK & SCRUB

Refreshing & cooling on application

① 35576 Love Nature Purifying 2-in-1 Mask & Scrub with Organic Tea Tree & Lime 75ml Merch price/100ml: £5.32 ~~£7.00~~ ② 34822 Love Nature Refreshing 2-in-1 Mask & Scrub with Organic Aloe Vera & Coconut Water 75ml Merch price/100ml: £5.32 ~~£7.00~~

Each for **£3.99**

Nourish skin with a sustainable sheet mask experience!

Helps hydrate and clarify skin



100% biodegradable material!

Helps to deliver soothing hydration and glow



③ 44282 Love Nature Hydrate & Clarify Sheet Mask 24ml Merch price/10ml: £0.83 ~~£4.00~~ ④ 44281 Love Nature Hydrate & Soothe Sheet Mask 24ml Merch price/10ml: £0.83 ~~£4.00~~

Each sheet mask for **£1.99**

Love Nature

ALL AGES

For dry skin

HELPS RESTORE BALANCE AND RADIANCE and works to smoothen and soften.



BEST PRICE OF THE YEAR

It's time to care for your skin with the goodness of nature. Love Nature sets every skin need free, with a happy family of natural organic extracts!

BEST PRICE OF THE YEAR

FROM NATURE WITH LOVE

ALL AGES

For oily skin

PURIFYING FACE OIL

Helps TARGET BLEMISHES

Helps PURIFY & SOOTHE SKIN

Works to TONE & TIGHTEN PORES



ALL AGES

For normal skin

Helps instantly MOISTURISE AND REPLENISH SKIN, has a soothing effect.



ALL AGES

For oily skin

HELPS PROVIDE LIGHTWEIGHT HYDRATION and mattifies your skin.



HERO INGREDIENT

ORGANIC TEA TREE & LIME

A perfect combo for oily skin, Tea Tree essential oil helps combat blemishes with its antimicrobial superpowers, while Lime tones your skin and leaves it mattified.

Each for

£3.99

① 34862 Love Nature Nourishing Face Cream with Organic Oat & Goji Berry 50ml Merch price/100ml: £7.98 ~~£8.00~~ ② 34821 Love Nature Hydrating Face Cream with Organic Aloe Vera & Coconut Water 50ml Merch price/100ml: £7.98 ~~£8.00~~ ③ 34845 Love Nature Mattifying Face Lotion with Organic Tea Tree & Lime 50ml Merch price/100ml: £7.98 ~~£8.00~~

Love Nature Purifying Face Oil with Organic Tea Tree & Lime 10ml Merch price/10ml: £2.99

34849 ~~£8.00~~ £2.99



**BEST
PRICE
OF THE
YEAR**

**FACE THE DAY
FLAWLESSLY**



waunt

**SKIN CARE WITH
SOMETHING EXTRA**

You're all about natural beauty – this is who you are. You want flawless skin, but prefer to enhance, rather than conceal. You're looking for Waunt!



DAY CREAM

PRIMER-EFFECT THAT INSTANTLY
BLURS RED SKIN TONES*

EYE CREAM

INSTANT
ILLUMINATING
EFFECT AROUND
EYES*



FACE MASK

CLARIFIES AND
MATTIFIES OILY
SKIN*



① Waunt 8 Hour Sleep
Eye Cream
15ml Merch price/10ml: £9.33
41353 ~~£22.00~~
£13.99

② Waunt Super Recover
Whipped Day Cream
50ml Merch price/100ml: £31.98
41365 ~~£25.00~~
£15.99

③ Waunt Mission Impurities
Heat Mask
75ml Merch price/100ml: £18.65
41382 ~~£22.00~~
£13.99

SUN PROTECTING POWER FROM SCANDINAVIA

Sun 360 has been designed to cover all of your skin protection needs, every day, whether you are at the beach, in the city, or out for a run.

BEST PRICE OF THE YEAR



POCKET-SIZE SUN STICK

with a high SPF for protecting the skin on the go.

① Sun 360 Sun Stick Body + Face SPF 30 High
8g Merch price/10g: £16.24

34899 ~~£17.00~~
£12.99

FOR KIDS



EASILY APPLICABLE SUN SPRAY

with a light, dry texture.



SOOTHE AND COOL SUN-EXPOSED SKIN

SOOTHING JELLY

that instantly calms sunburnt skin.



Sun 360 After Sun Jelly Body + Face
150ml Merch price/100ml: £4.66

35759 ~~£14.00~~
£6.99

② Rebel Sunglasses
PC, polyester. W14.1 x H5.5cm.

44641 ~~£14.99~~
£12.99



In trendy burgundy with
MARBLED EFFECT

③ Sun 360 Cream Sensitive Body + Face SPF 50+ Very High
50ml Merch price/100ml: £27.98

35760 ~~£19.00~~
£13.99

④ Sun 360 Lotion Body + Face SPF 30 High
125ml Merch price/100ml: £11.19

34890 ~~£19.00~~
£13.99

⑤ Sun 360 Kids Cream Body + Face SPF 50 High
125ml Merch price/100ml: £11.19

34896 ~~£19.00~~
£13.99

⑥ Sun 360 Dry Mist Body + Face SPF 50 High
150ml Merch price/100ml: £9.33

34891 ~~£19.00~~
£13.99

OPTIMALS

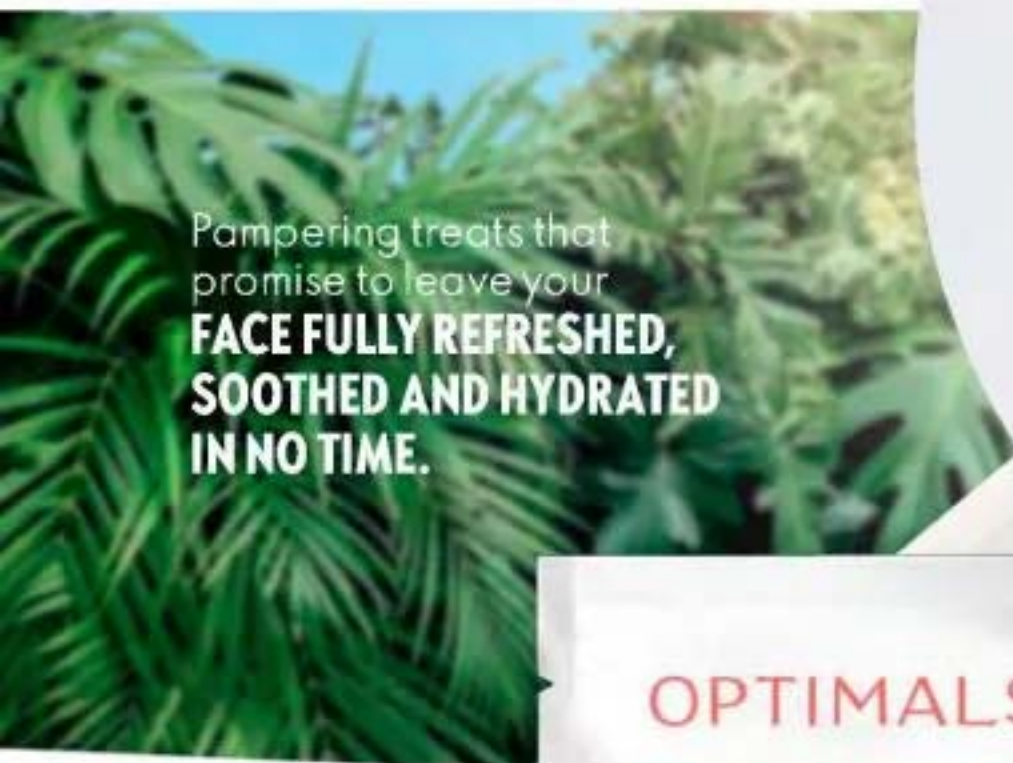

Pampering treats that promise to leave your **FACE FULLY REFRESHED, SOOTHED AND HYDRATED IN NO TIME.**

BEST PRICE OF THE YEAR

NATURALLY, HEALTHY-LOOKING SKIN

FORMULATED TO purify the skin without making it feel dry.

DEEPLY AND GENTLY cleanses the skin, smoothing skin tone and texture.

3-IN-1 LEAVE ON SOLUTION: cleanses, removes make-up, hydrates skin.

A NATURAL SPONGE designed for fast and gentle make-up removal and deep cleansing.



Remove clear film first. Apply to clean dry skin, then remove white film and leave for 10 minutes. Do not rinse. Avoid direct contact with eyes.

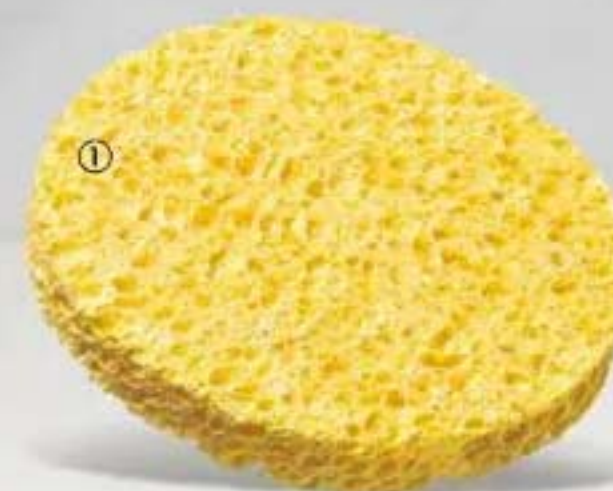

① **Cleansing Sponge**
Size 70 x 10mm approx.
~~8617 £2.50~~
£1.49



② 42610 Optimals Soothing Micellar Cleansing Water 150ml
Merch price/100ml: £3.33 ~~£10.00~~ ③ 42609 Optimals Clarifying Creamy Cleanser 150ml Merch price/100ml: £3.33 ~~£10.00~~ ④ 42613 Optimals Deep Cleansing Gel 150ml Merch price/100ml: £3.33 ~~£10.00~~

Each toner and cleanser for

£4.99

BEST PRICE OF THE YEAR

Optimals Insta-cool Anti-fatigue Hydro Gel Cooling Face Patches
7g Merch price/10g: £4.27

35916 ~~£5.00~~
£2.99

Each botanical element in the **Age Revive** range helps you achieve beautiful, younger looking skin while **Hydra Radiance** quenches its thirst.

A TAILORED SOLUTION FOR SKIN NEEDS

AGE REVIVE FOR SIGNS OF PREMATURE AGEING

HYDRA RADIANCE FOR DEHYDRATED/DRY SKIN



INSTANTLY HYDRATES AND RE-PLUMPS YOUR SKIN while helping to minimise the appearance of pores.



REDUCES APPEARANCE OF FINE LINES AND WRINKLES as well as signs of tiredness, brightens the skin.



INTENSIVELY HYDRATES, enhances radiance, and helps protect against free radical damage.



DEEPLY HYDRATES, leaves dry and sensitive skin refreshed, supple and calmed.



BEST PRICE OF THE YEAR

BEST PRICE OF THE YEAR

① Optimals Age Revive Serum
30ml Merch price/10ml: £3.00
~~42551 £18.00~~
£8.99

② Optimals Age Revive Eye Cream
15ml Merch price/10ml: £4.66
~~42550 £14.00~~
£6.99

① Optimals Hydra Radiance Serum
30ml Merch price/10ml: £2.33
~~42567 £14.00~~
£6.99

② Optimals Hydra Radiance Day Cream Light
50ml Merch price/100ml: £11.98
~~42580 £12.00~~
£5.99

ROYAL VELVET

ENVELOP YOURSELF IN THE OPULENCE OF VELVET

REPAIRING NIGHT CREAM

Improves skin firmness and helps reduce the appearance of fine lines and wrinkles while you sleep.



**BEST
PRICE
OF THE
YEAR**

Black Iris Infusion is the true heart of Royal Velvet. Its flavonoid-rich formula helps to reinforce your skin's structure, tone, hydration and elasticity.



ULTRA-SMOOTHING CAPSULES

Nourishing blend of 5 oils and Black Iris Infusion leaves skin smoother and softer, with visibly reduced fine lines and wrinkles.



HERO INGREDIENT

BLACK IRIS INFUSION

A combination of Iris Isoflavones and Meteorite Minerals helps boost collagen and elastin production, resulting in improved skin firmness and reduced appearance of fine lines and wrinkles.

① Royal Velvet Repairing Night Cream
50ml Merch price/100ml: £27.98

22814 ~~£23.00~~
£13.99



130

⑤ Royal Velvet Ultra Firming Capsules
28 capsules to be used in 4 weeks.
Merch price/10pcs: £5.00

24547 ~~£26.00~~
£13.99

131



Our best-selling
mascara

£5.99

The ultimate **MULTI-BENEFIT MASCARA!**

- **VOLUMISES**
- up to 16X times more volume^Δ
- **LENGTHENS**
- up to 68% more length^Δ
- **CURLS**
- up to 119% more curl^Δ
- **SEPARATES***
- **CARES***

^ΔClinically Tested

*Consumer Tested

THE ONE 5-in-1 Wonder Lash Mascara

Multi-benefit mascara to deliver the ultimate in 5-in-1 benefits, with better results than ever before – clinically proven! With the exclusive Wonder Brush to volumise, lengthen, curl, separate, and provide care. Smudge proof, flake proof, long wear formula in intense black. Paraben free. 8ml Merch price/10ml: £7.49

£11.00



55

WEEKLY OFFERS ALL YEAR LONG!

Join us in celebrating Oriflame's 55th Anniversary all year long! Stay tuned and discover a new offer each week.

1ST WEEK (03.08 - 09.08)

① THE ONE Everlasting Sync Foundation SPF 30
30ml Reg price/10ml: £4.67

£14.00

£6.99*

**You can buy any number of products, until stocks last.*



SKIN RESPONSE TECHNOLOGY
Attracts and retains moisture



LONG WEAR*
**Clinically proven*



SPF



2ND WEEK (10.08 - 16.08)

② Debonair Eau de Toilette
75ml Reg price/100ml: £42.67

42726 £32.00

£16.99*

**You can buy any number of products, until stocks last.*



DEBONAIR



WOODY - AROMATIC
Cardamom, Cedarleaf, Sandalwood

3RD WEEK (17.08 - 23.08)

③ Love Potion Eau de Parfum
50ml Reg price/100ml: £64.00

42751 £32.00

£17.99*

**You can buy any number of products, until stocks last.*

**LOVE
POTION**



ORIENTAL VANILLIC FRUITY
Ginger, Cocoa flower,
Chocolate



